

Fokker Dr. 1
#15134
Bauanleitung

PICHLER

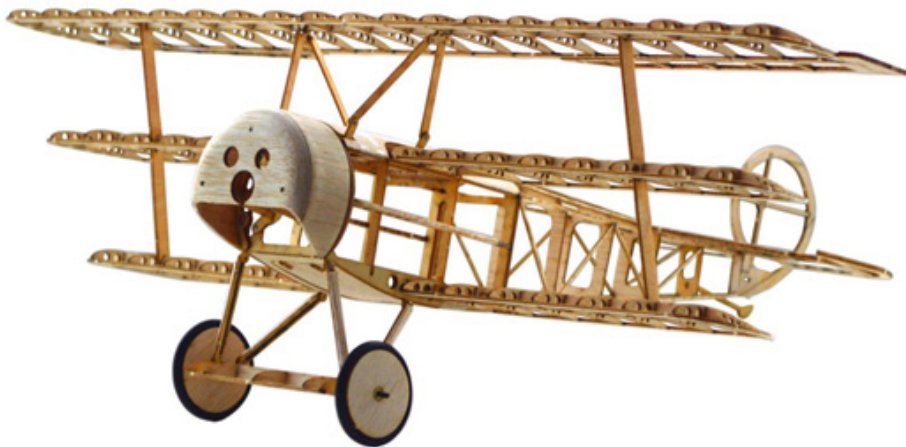

Packungsinhalt	
Balsaholzplatte	4
Lindenholzplatte	1
Kohlefaserstab	2
Micro Scharnier	1
Micro Schraube	20
Rad	2
Schrumpfschlauch	1
Mini Magnet	8
Bauplan	3
Bespannpapier	1

Teil 1 - Rahmen

1



2

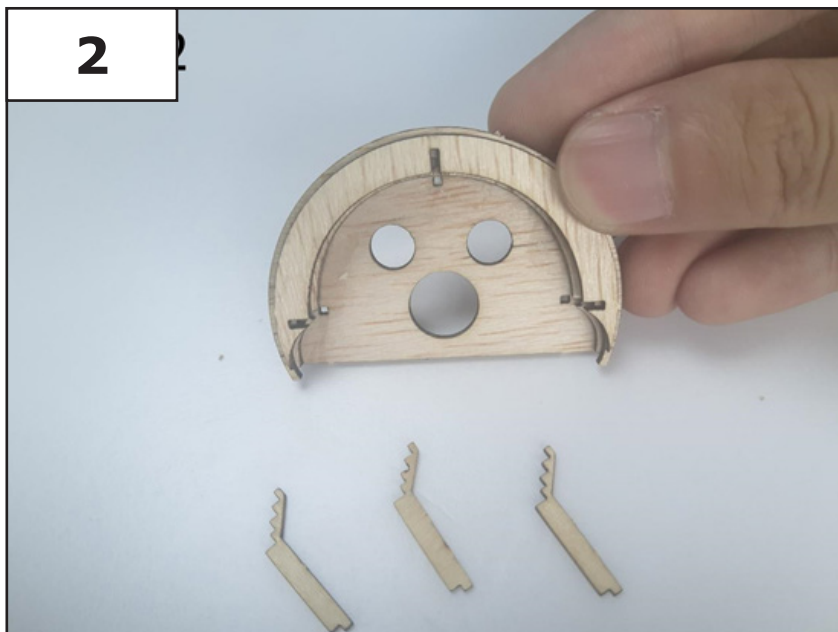

3



Teil 1 - Rahmen

4

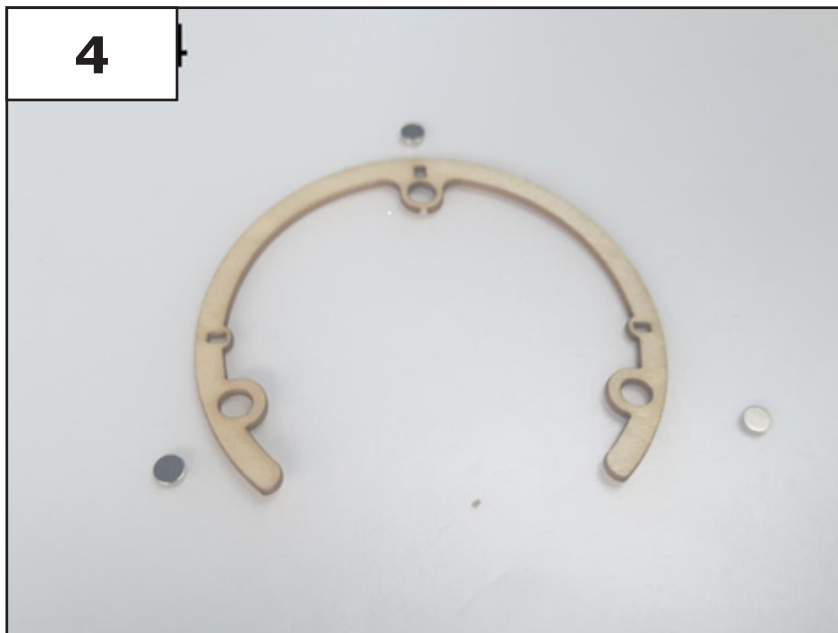

5

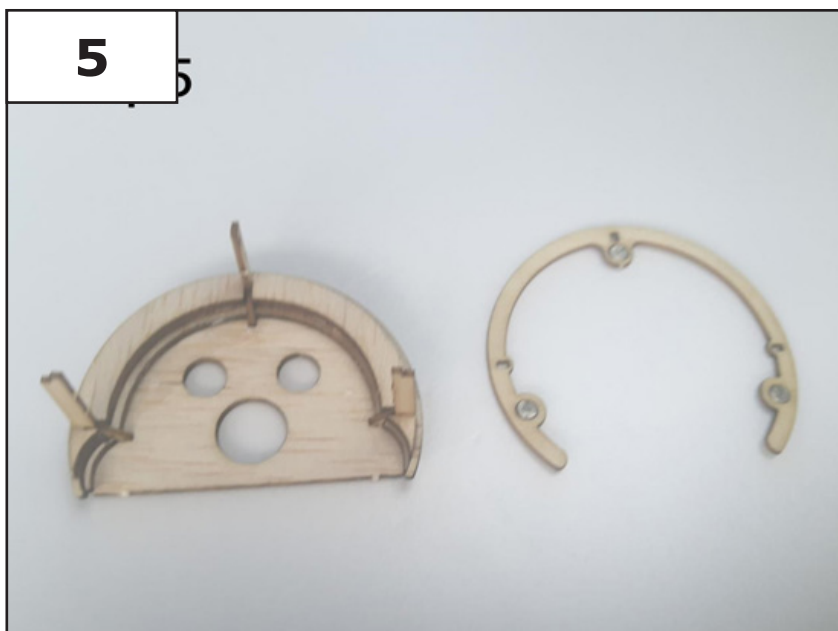

6

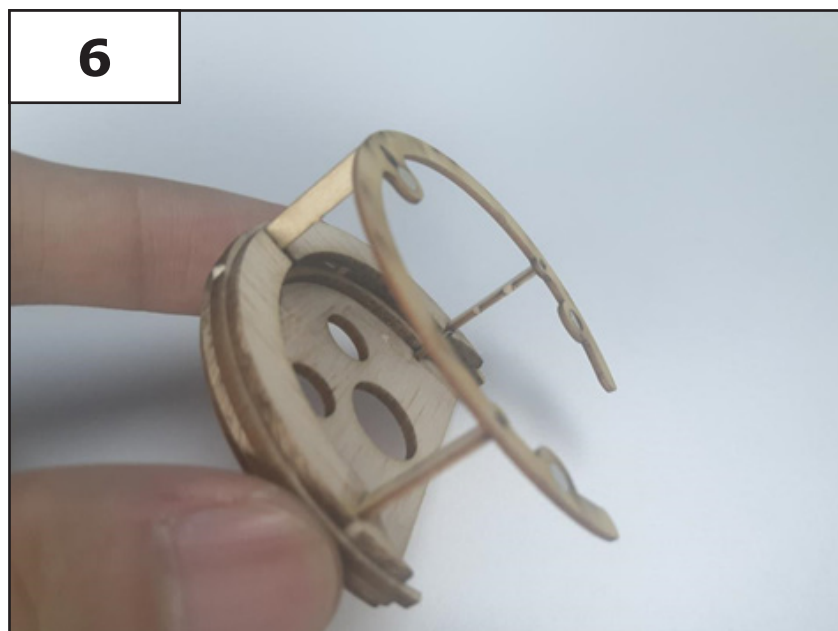

Teil 1 - Rahmen

7

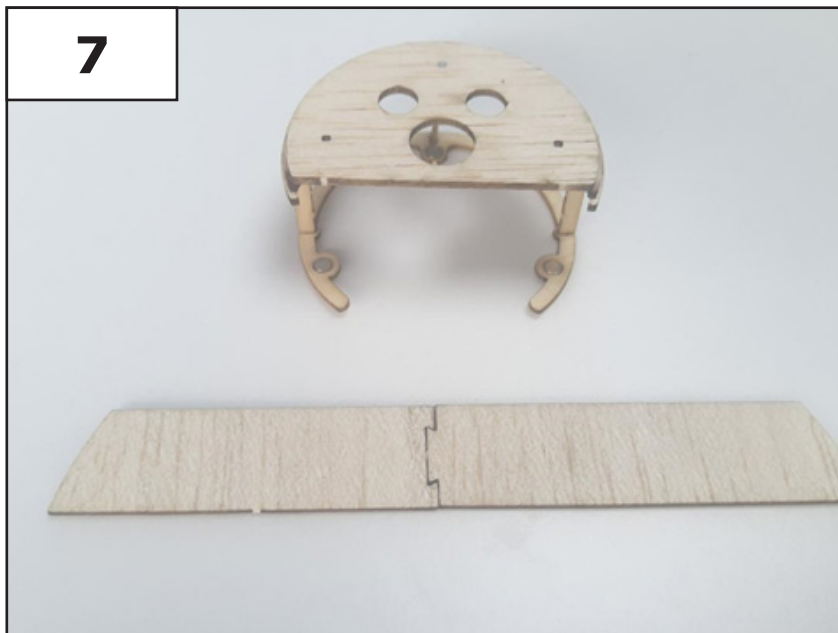

8



9



Teil 1 - Rahmen

10

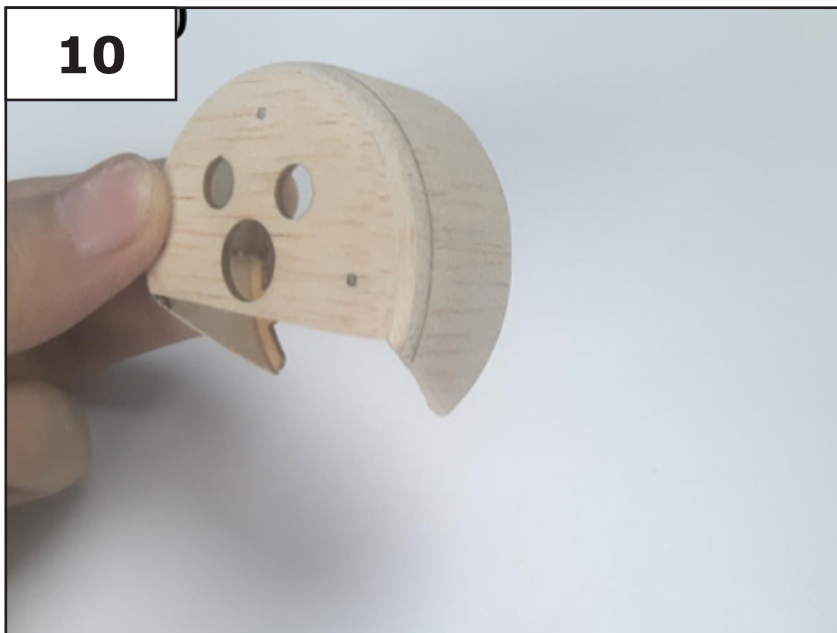

11

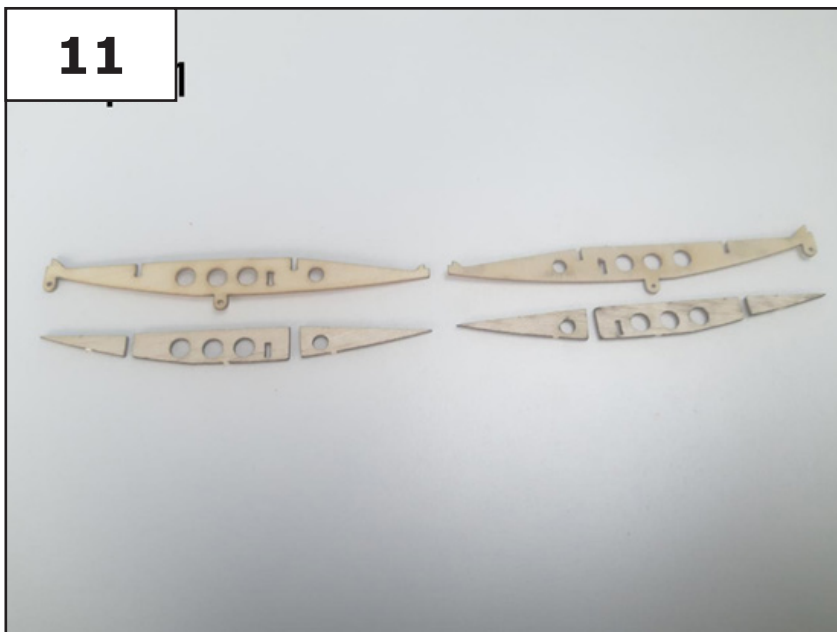

12

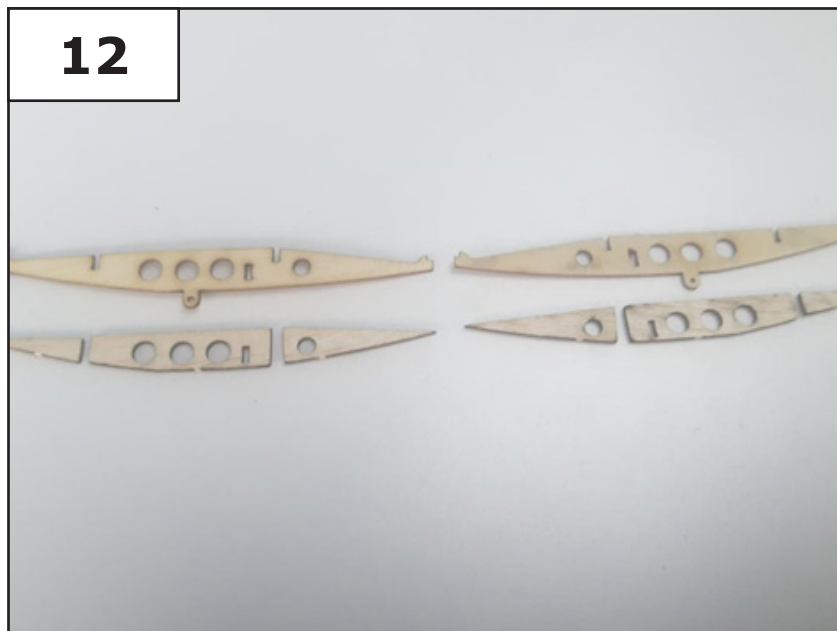

Teil 1 - Rahmen

13

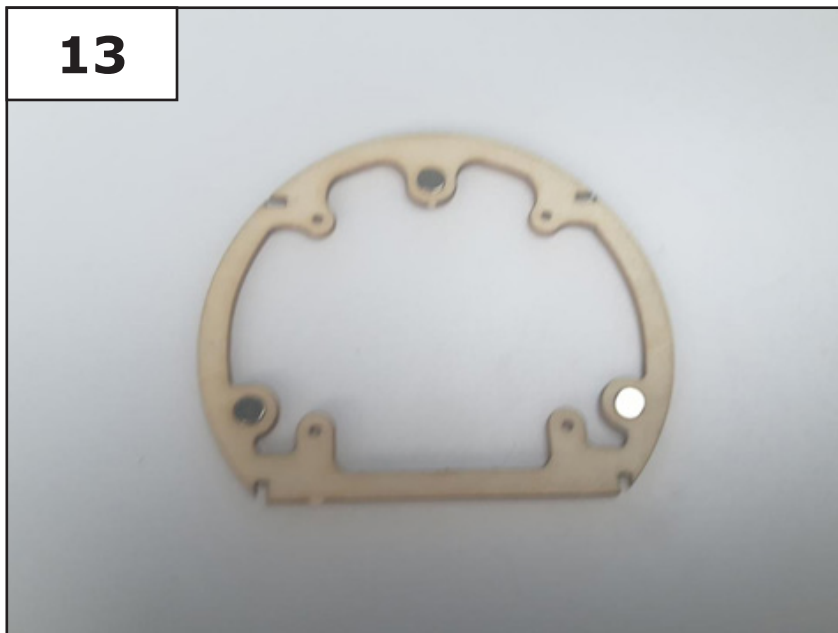

14

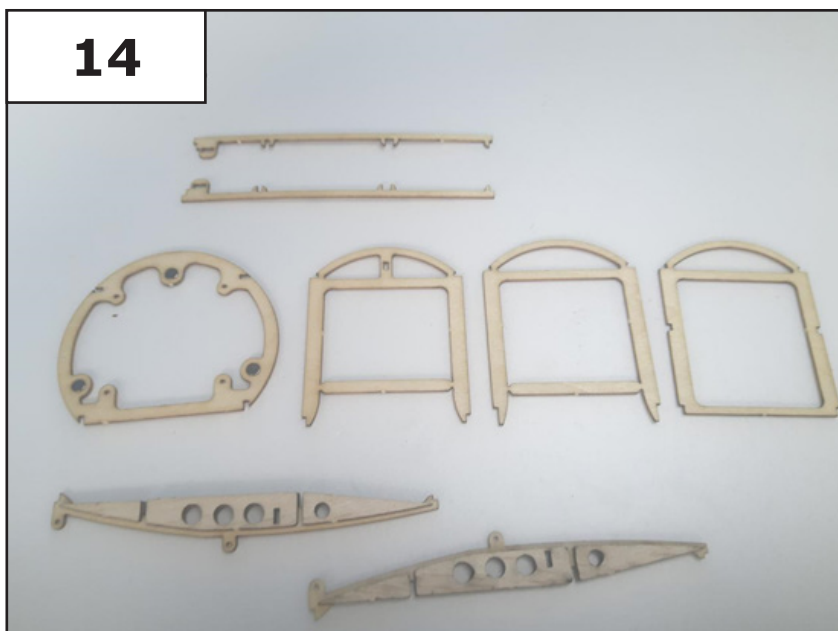

15

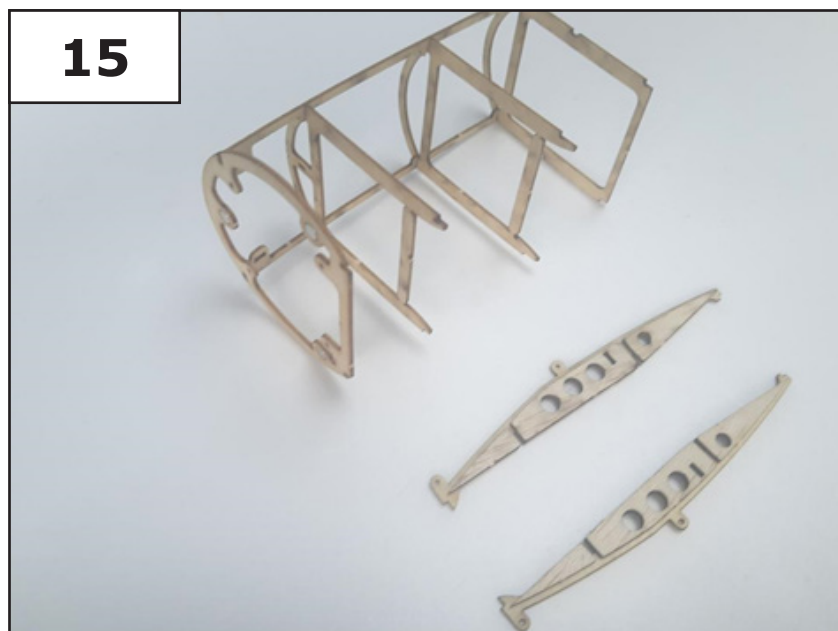

Teil 1 - Rahmen

13

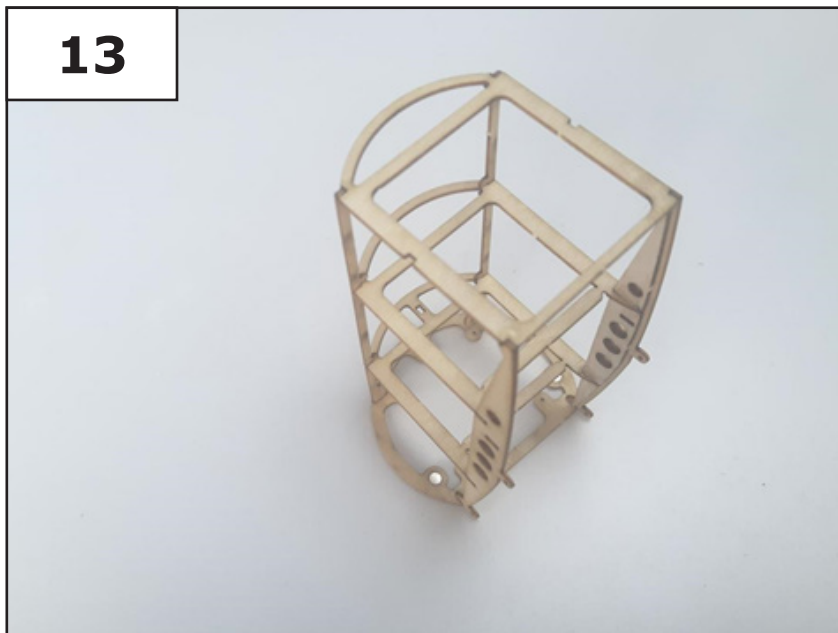

17

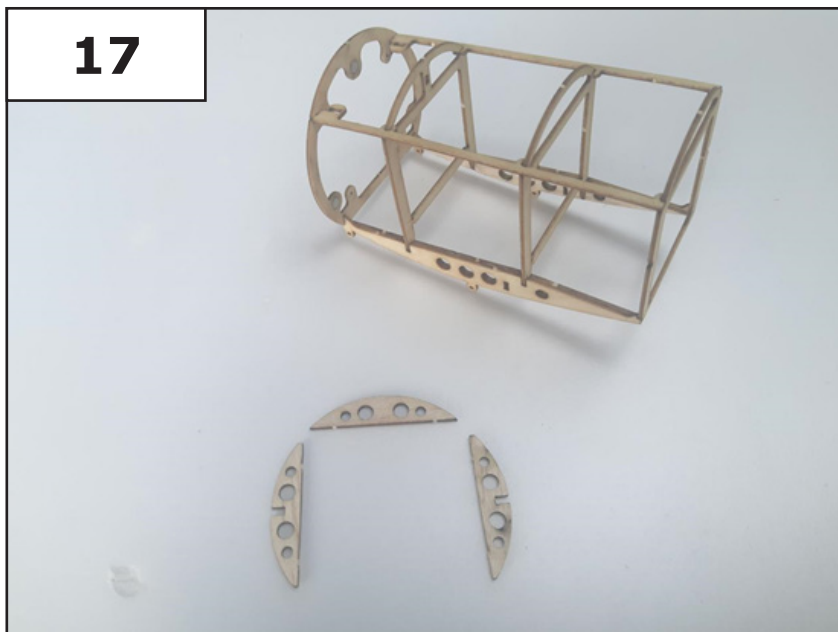

18

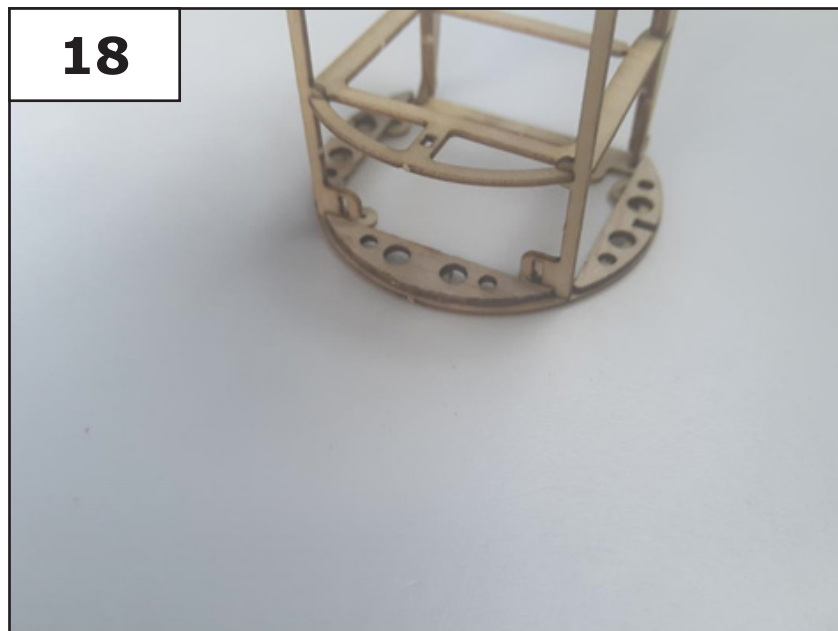

Teil 1 - Rahmen

19

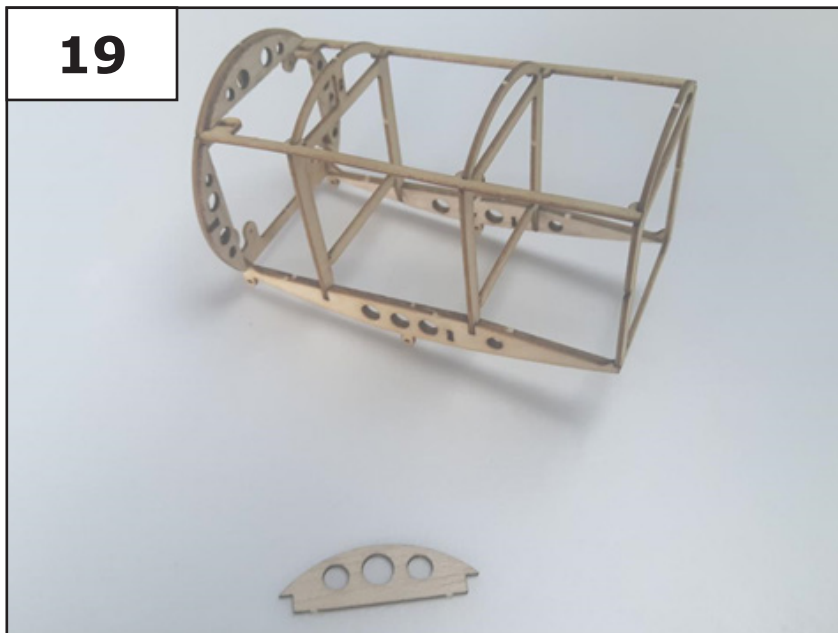

20

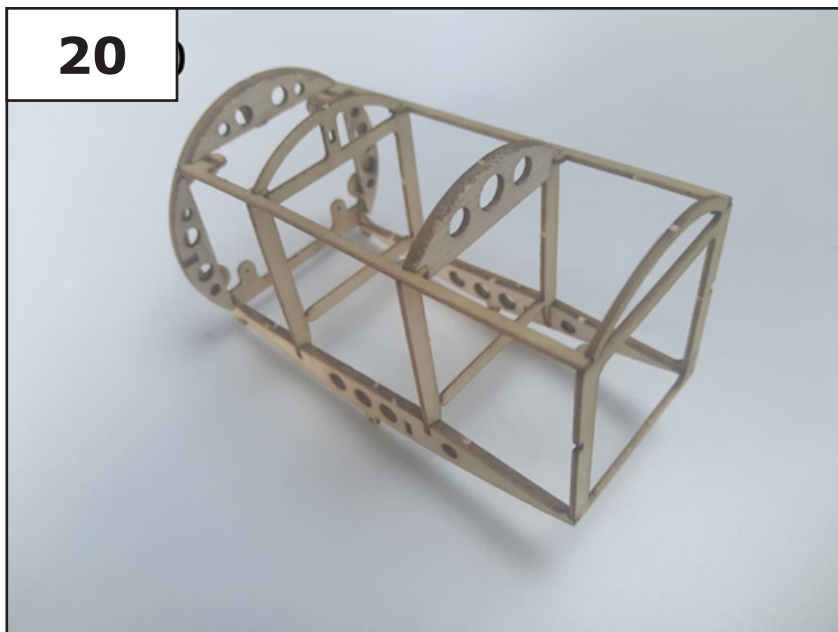

21

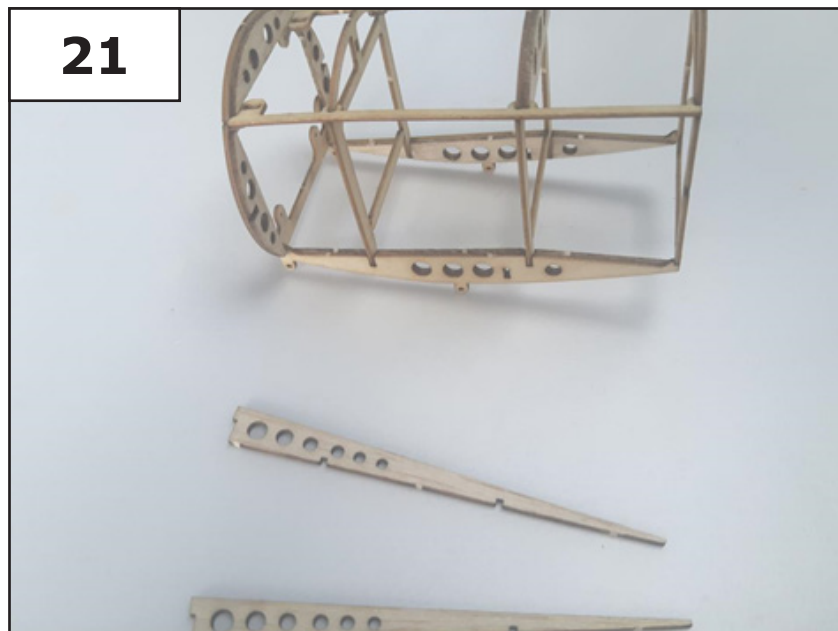

Teil 1 - Rahmen

22

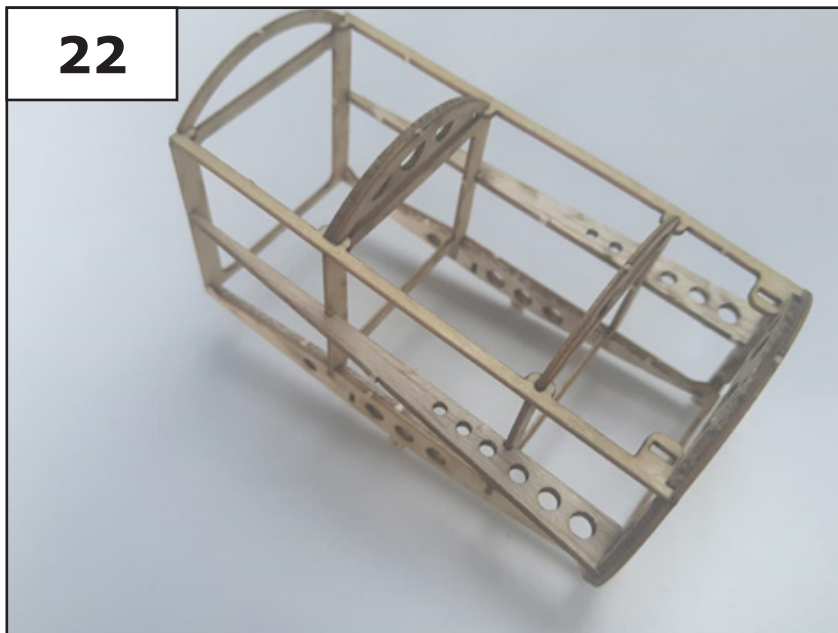

23

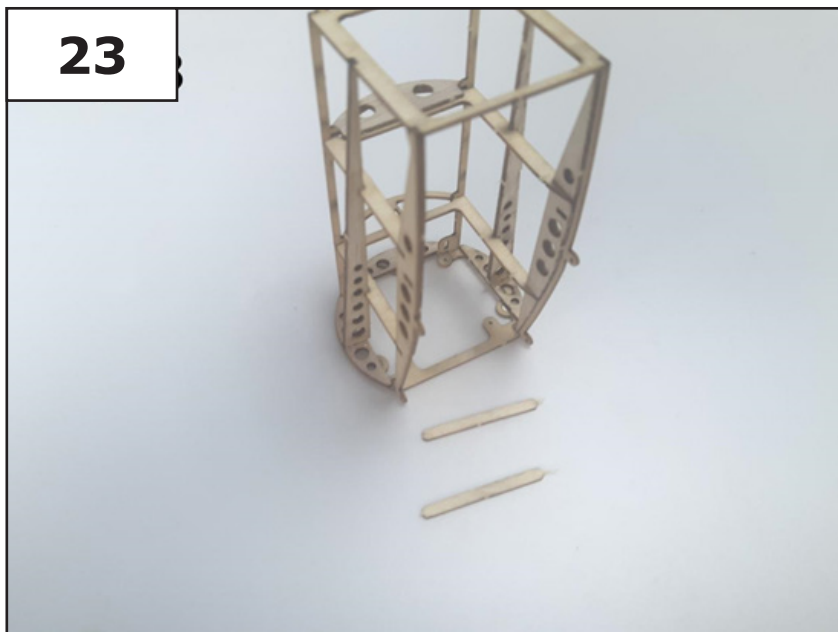

24

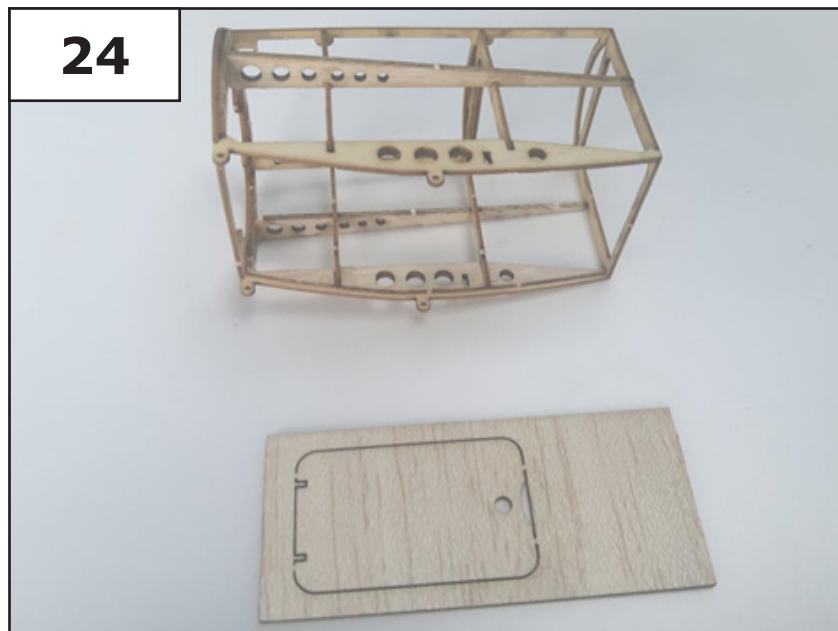

Teil 1 - Rahmen

24

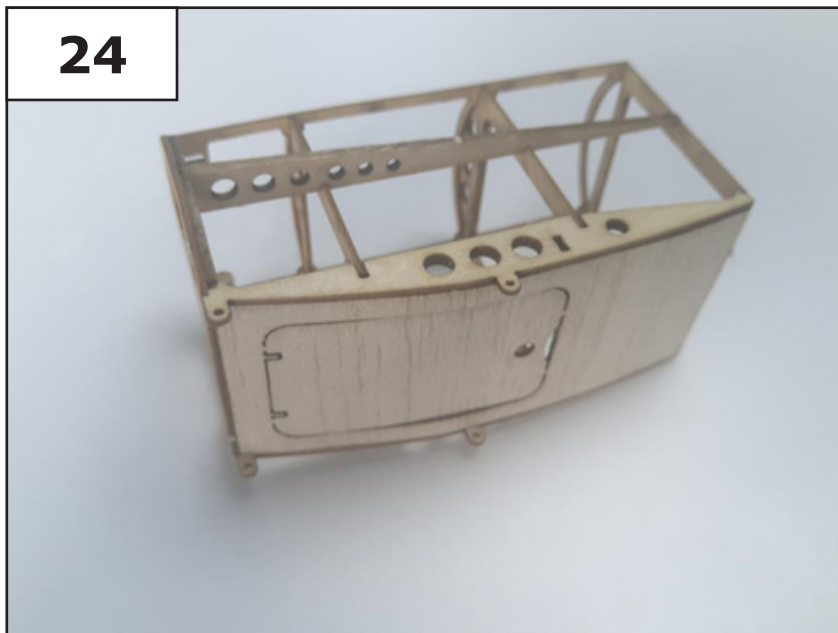

26

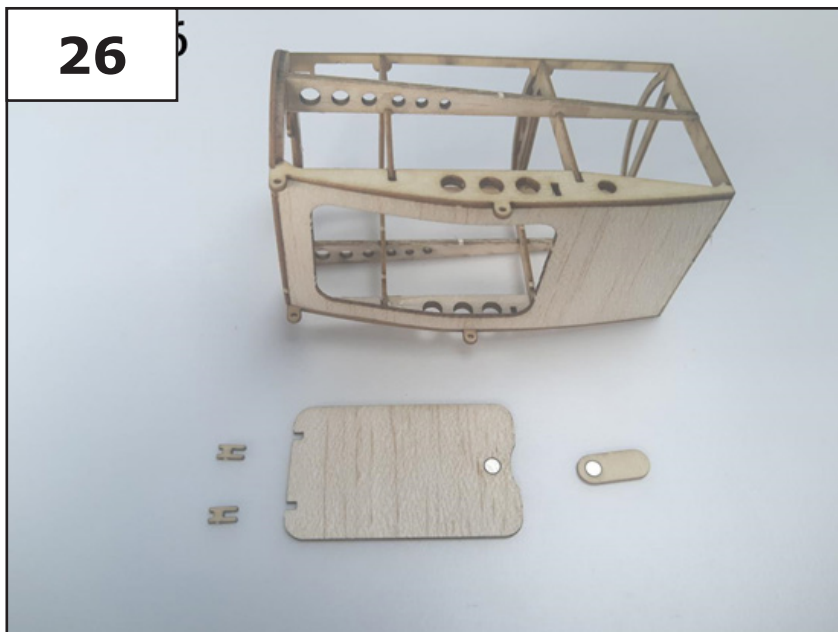

27

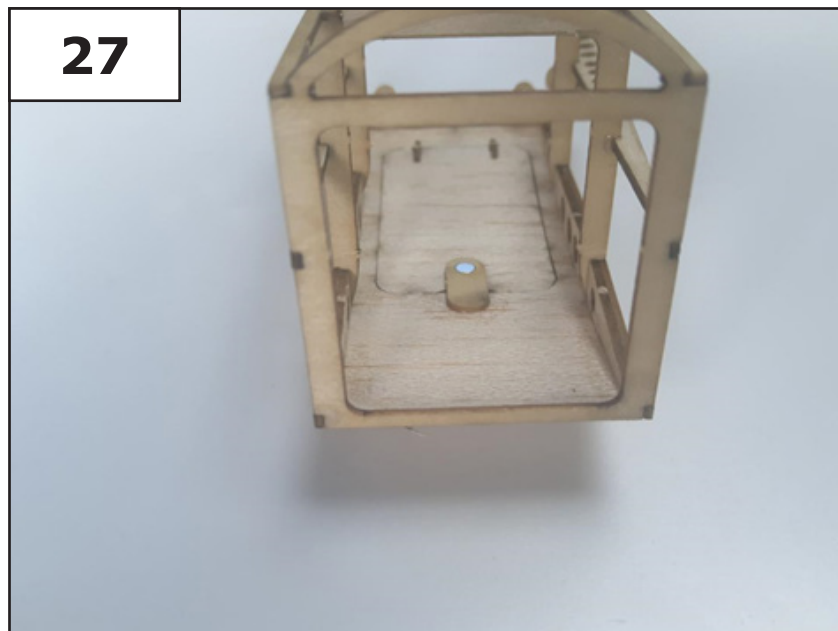

Teil 1 - Rahmen

28

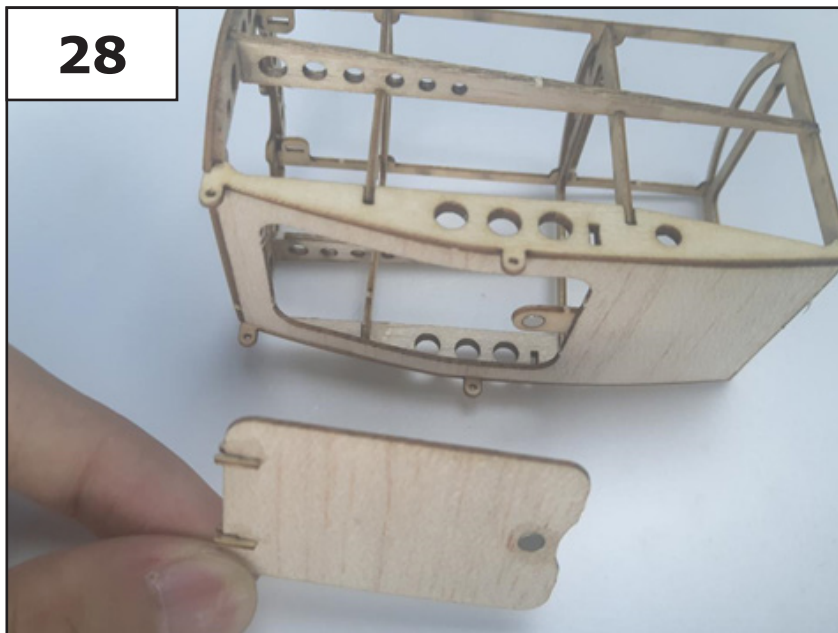

29

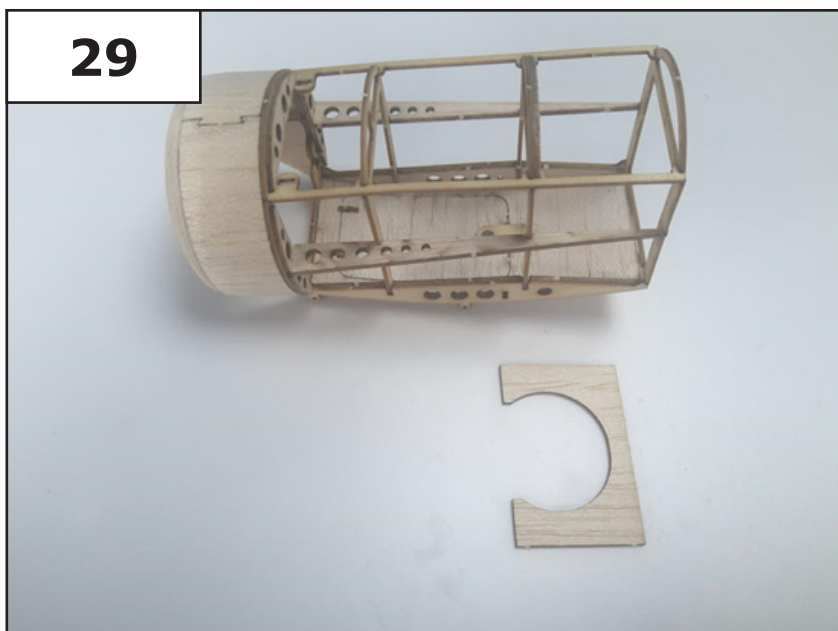

30

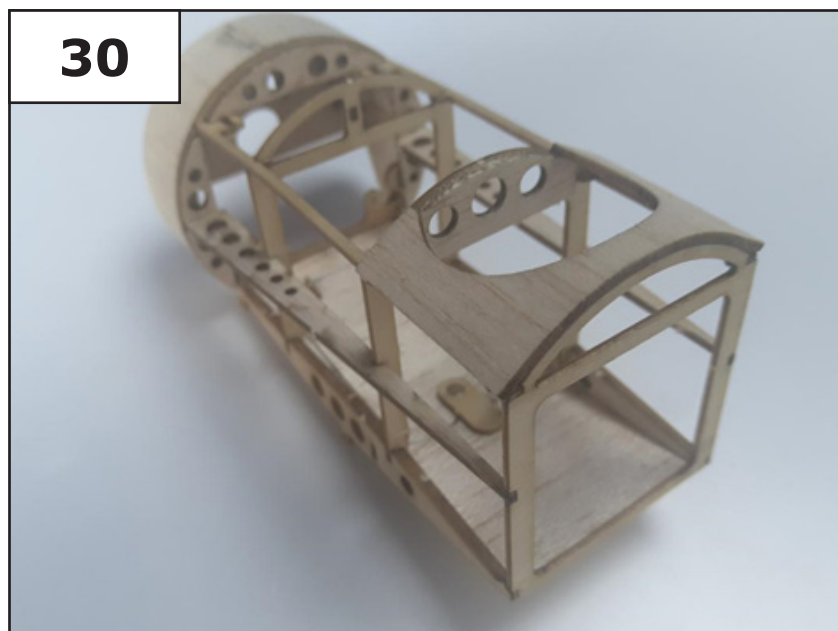

Teil 1 - Rahmen

31

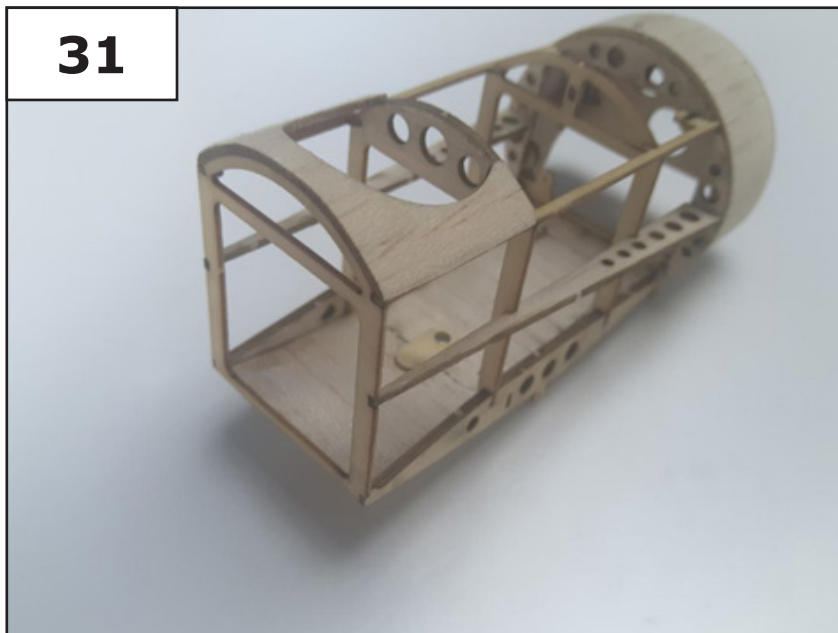

32

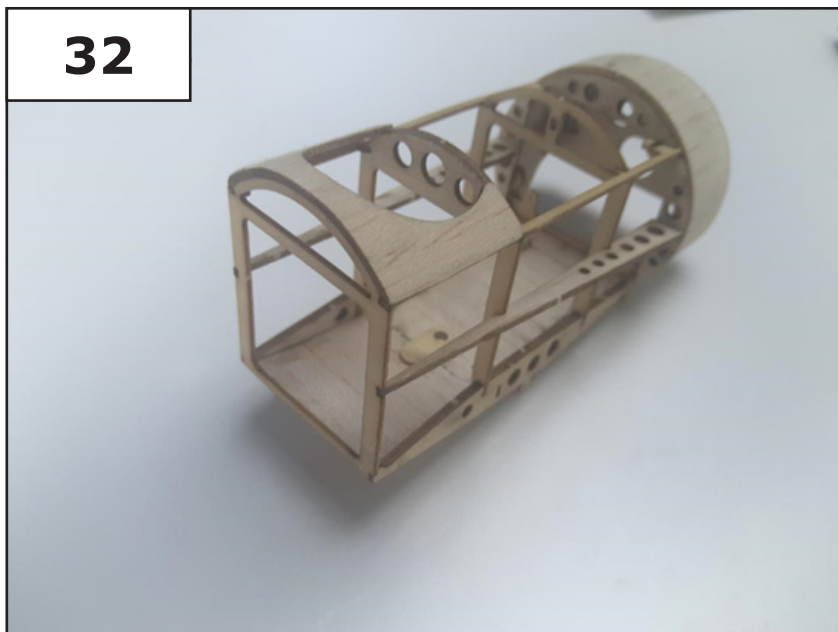

33

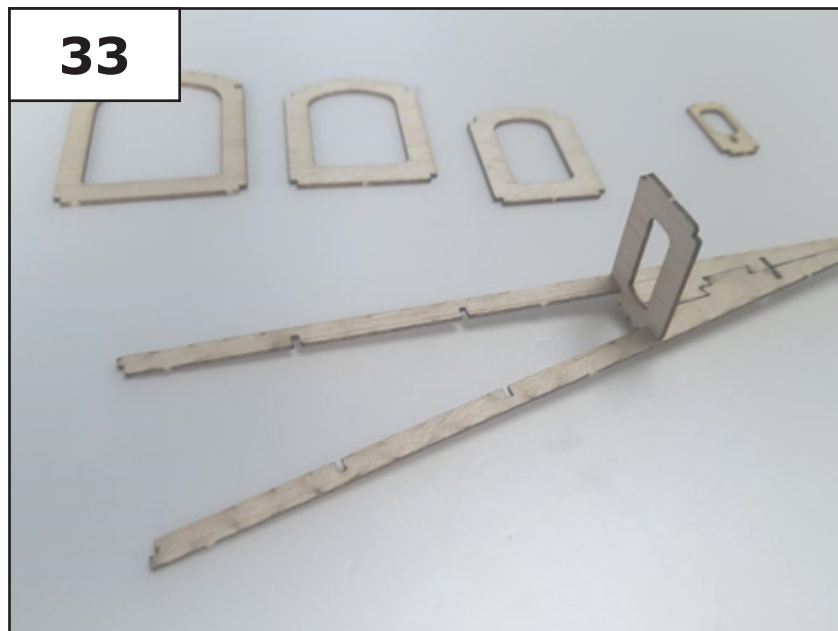

Teil 1 - Rahmen

34

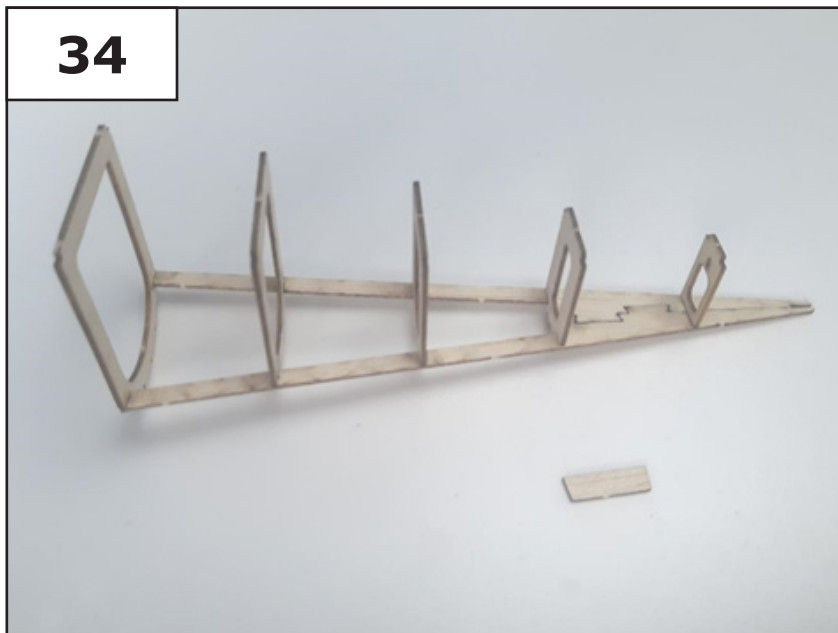

35

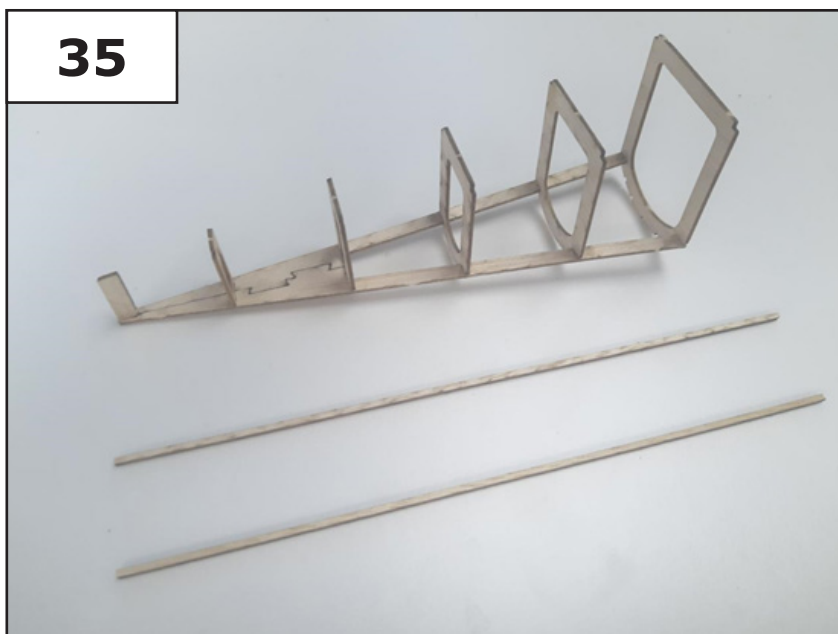

36

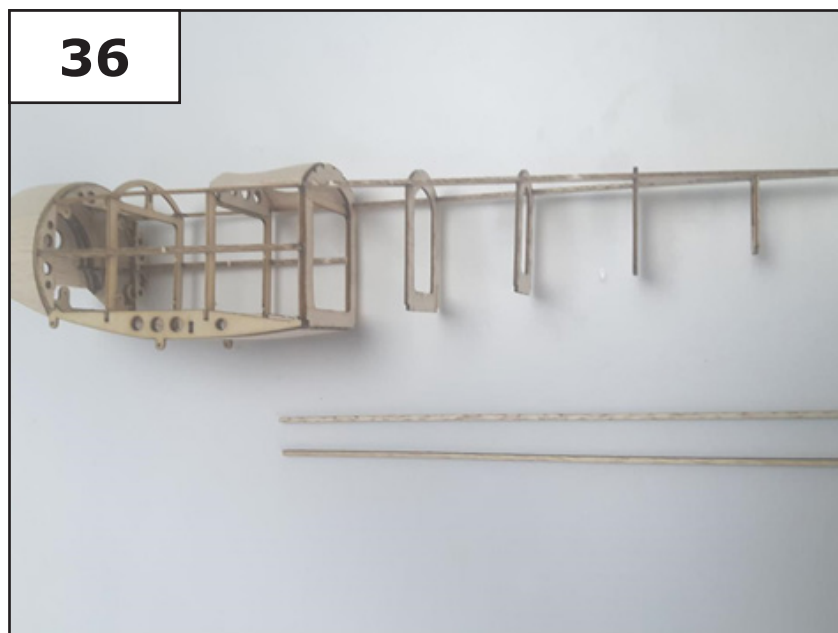

Teil 1 - Rahmen

37

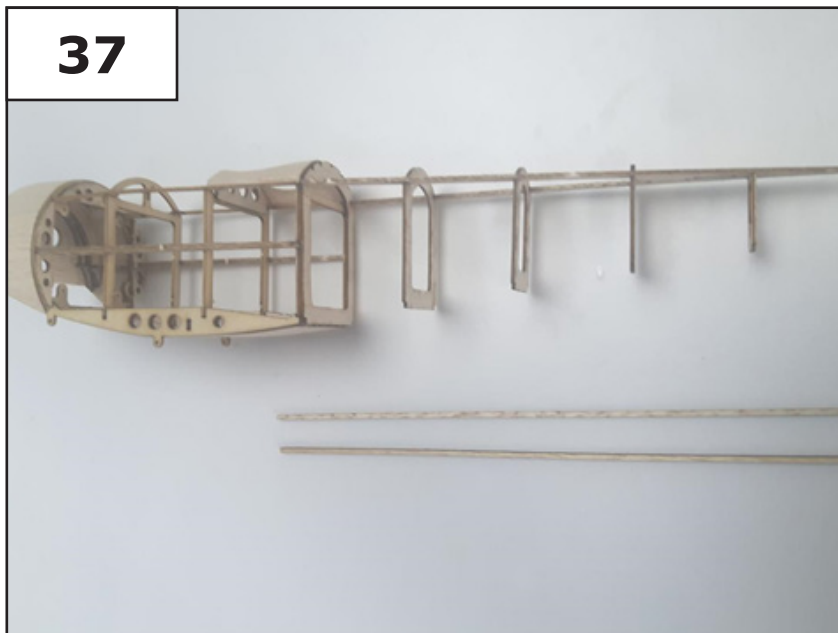

38

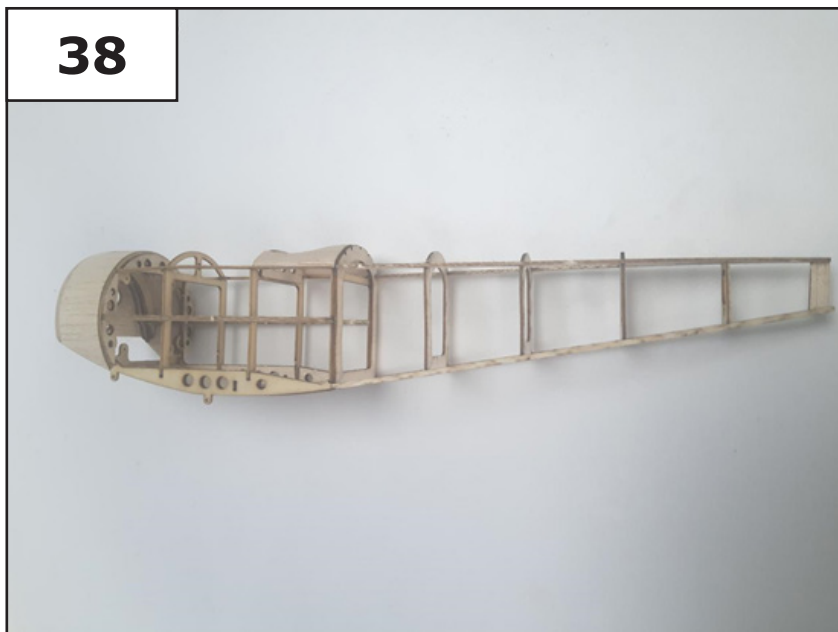

39



Teil 1 - Rahmen

40



41

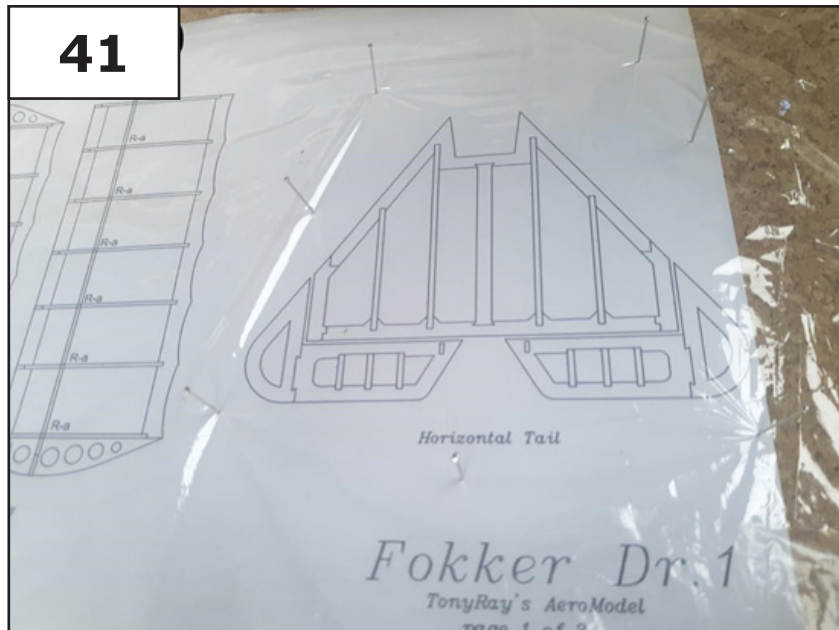

42

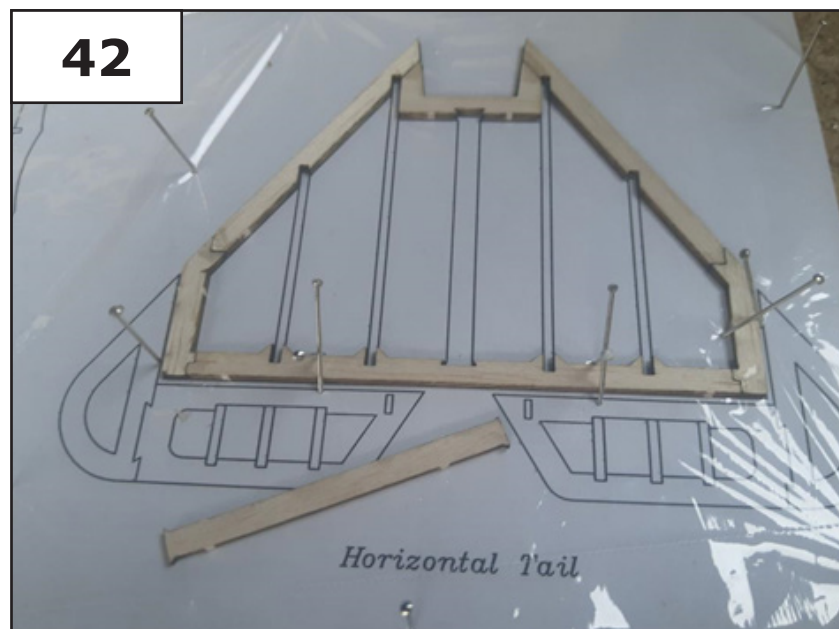

Teil 1 - Rahmen

43

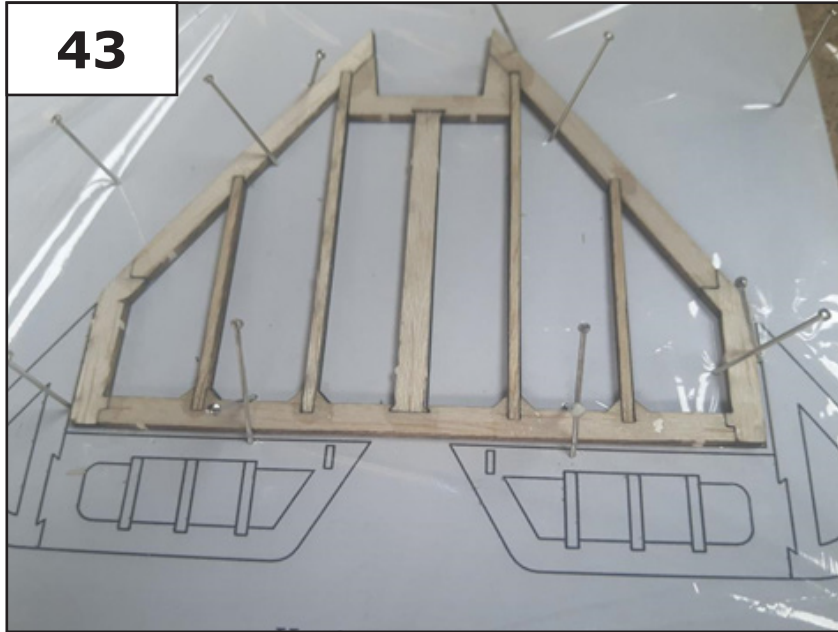

44

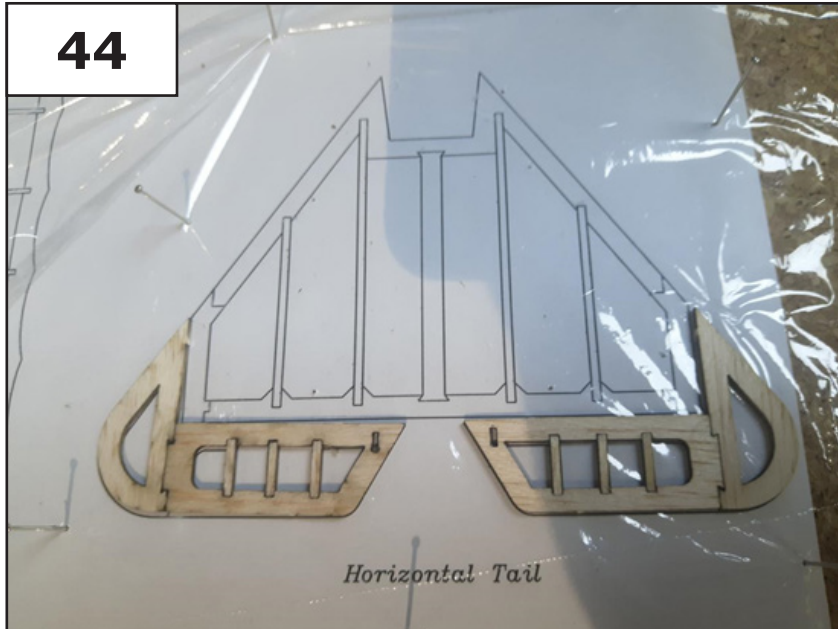

45

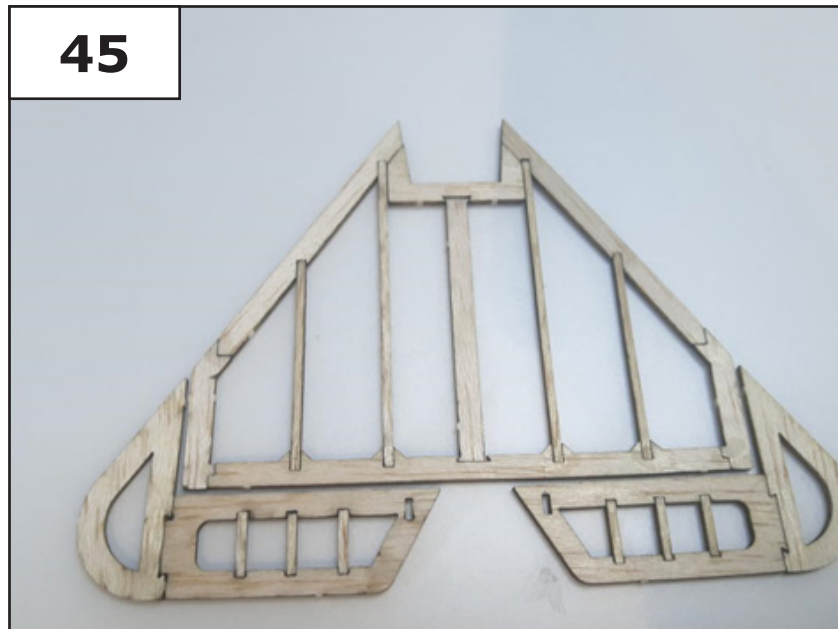

Teil 1 - Rahmen

46

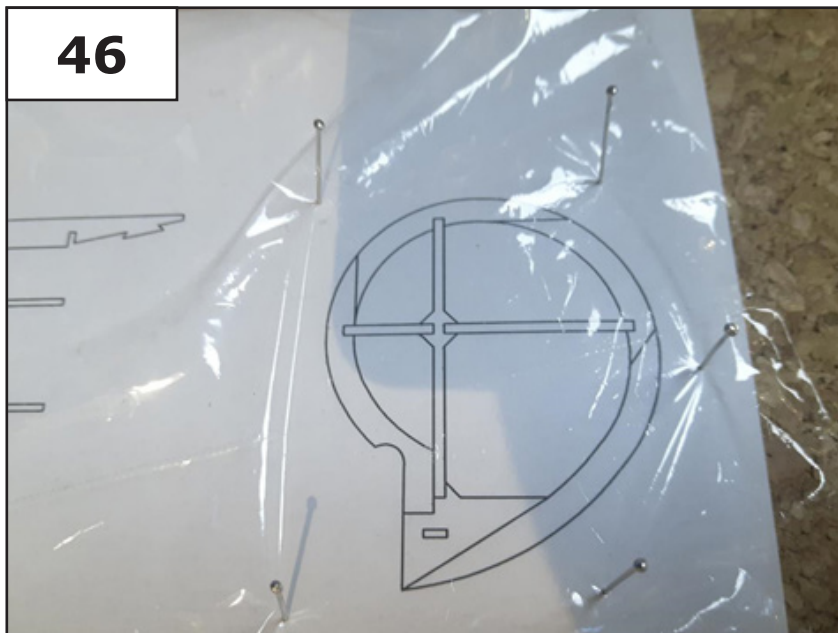

47

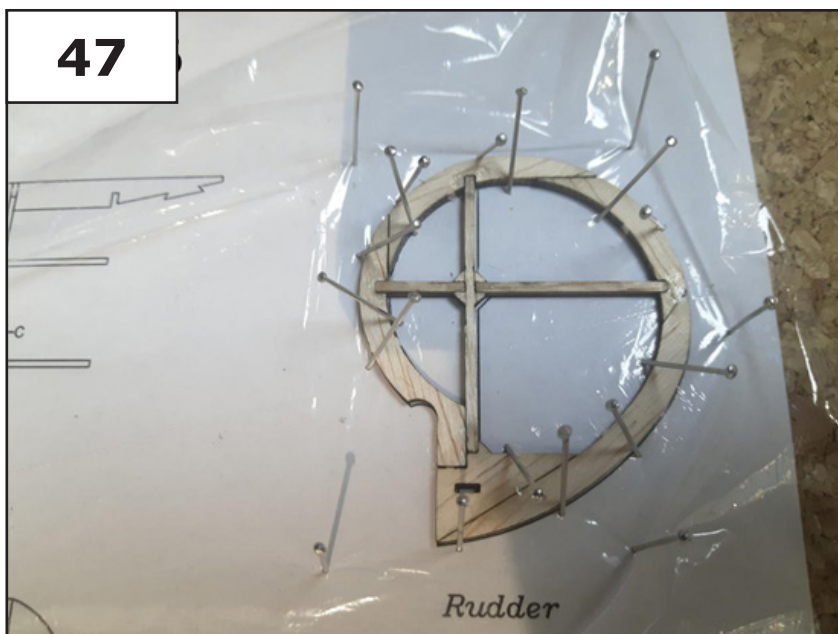

48



Teil 1 - Rahmen

49

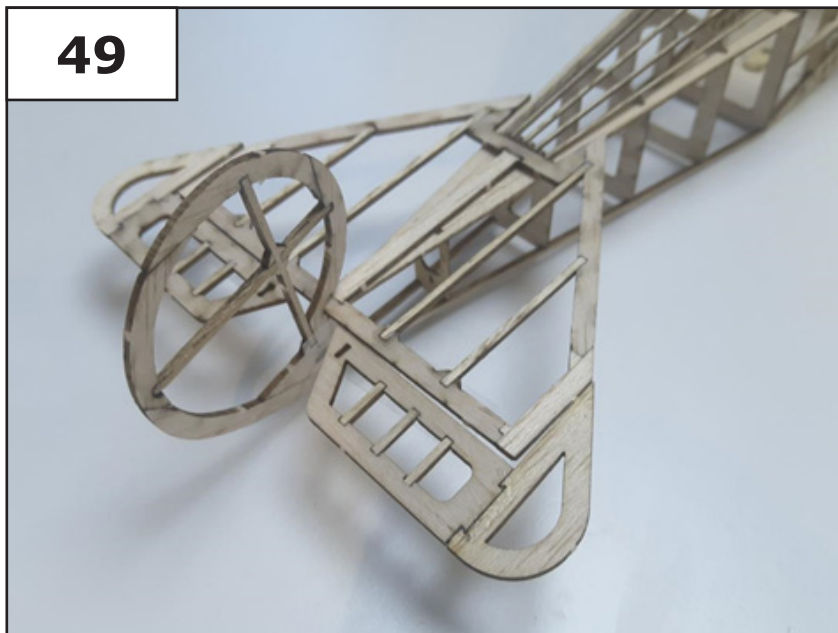

50

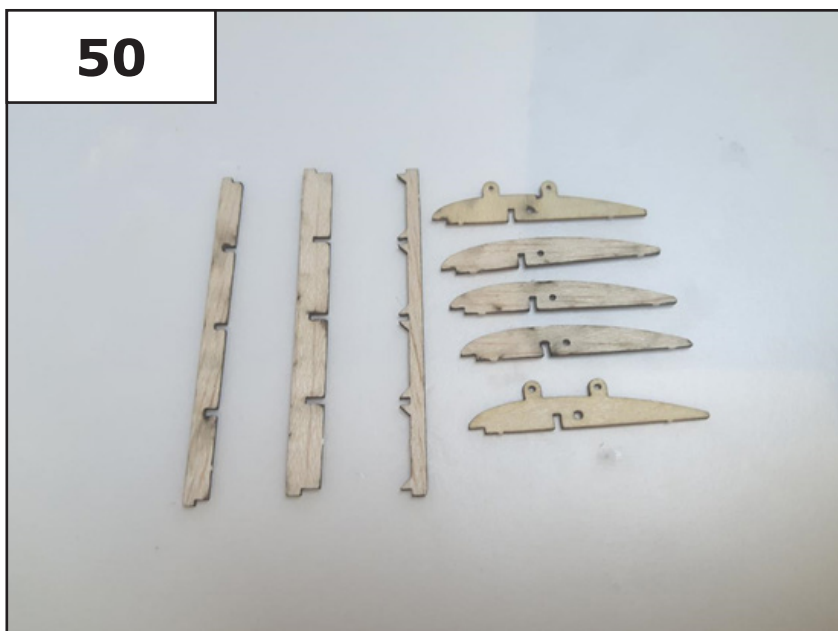

51

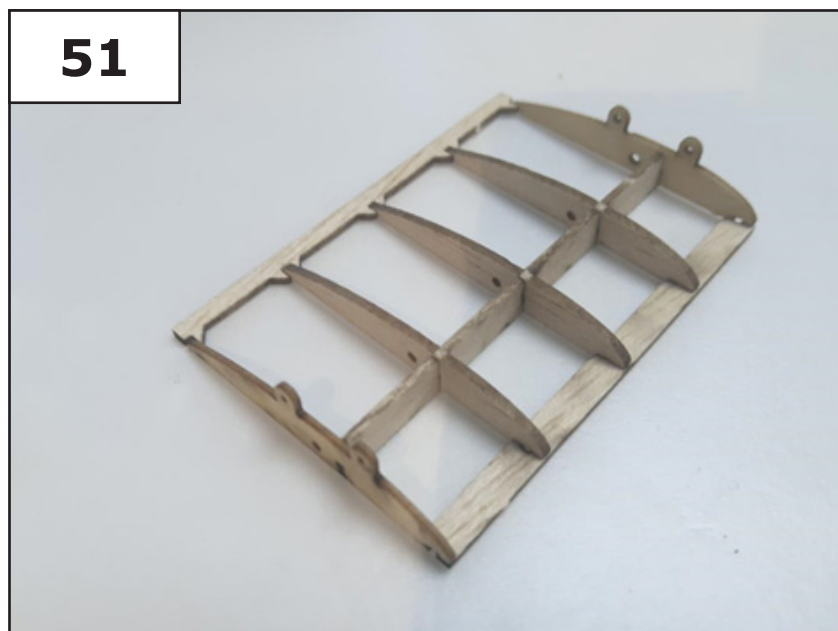

Teil 1 - Rahmen

52

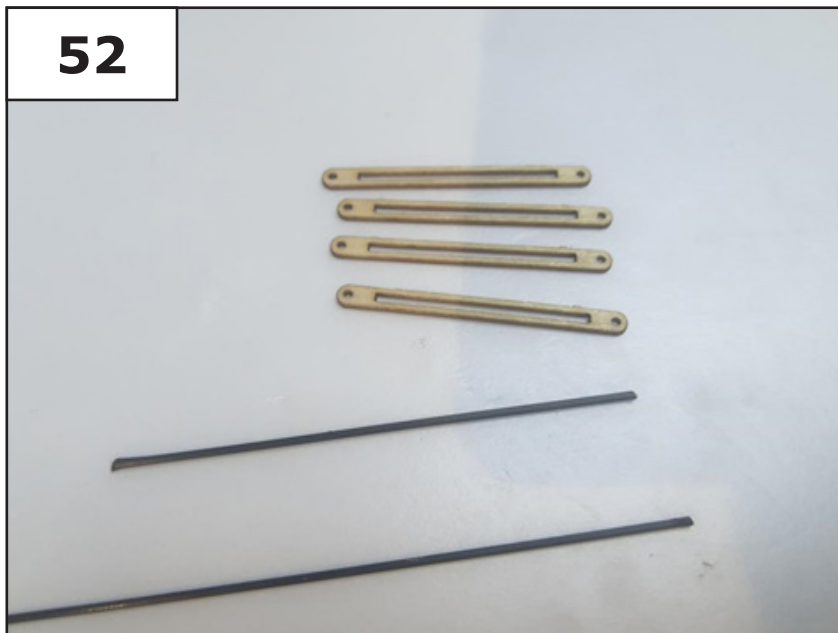

53

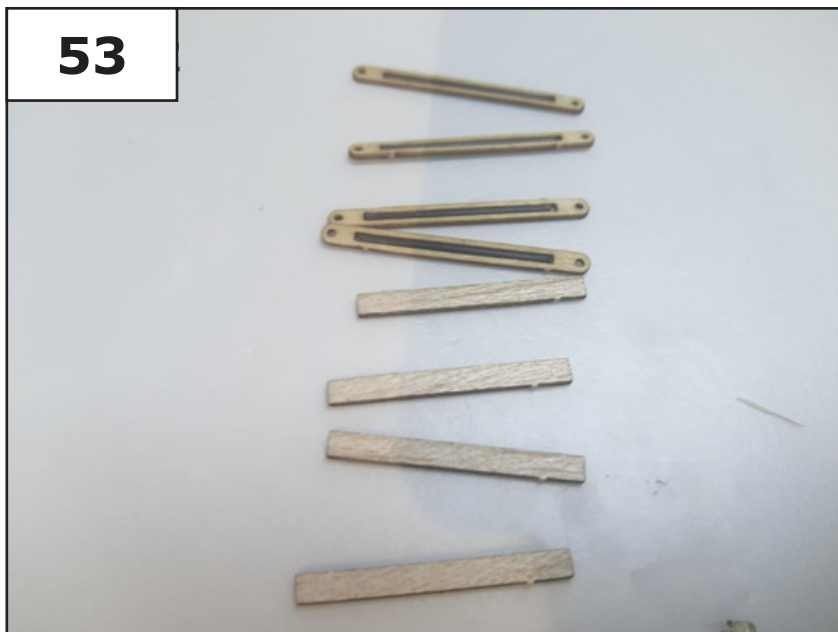

54

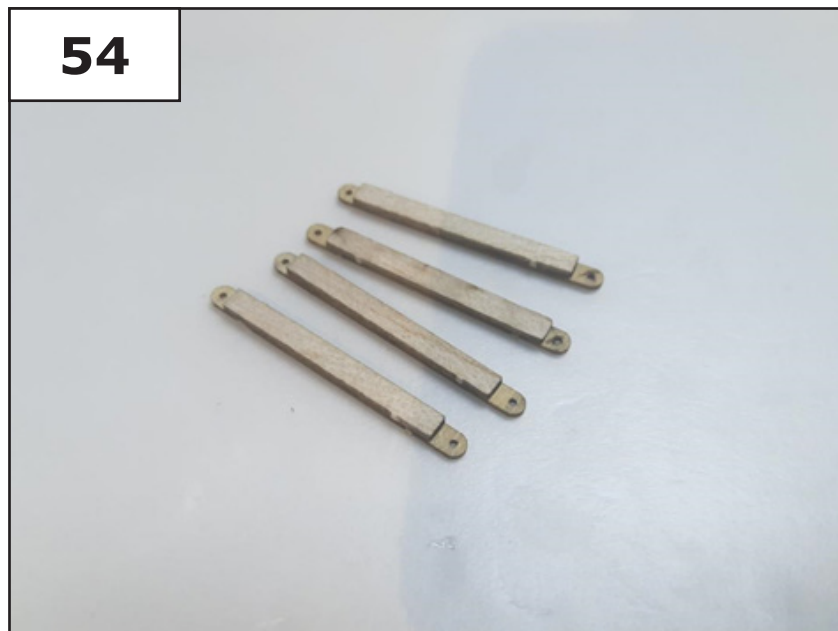

Teil 1 - Rahmen

55

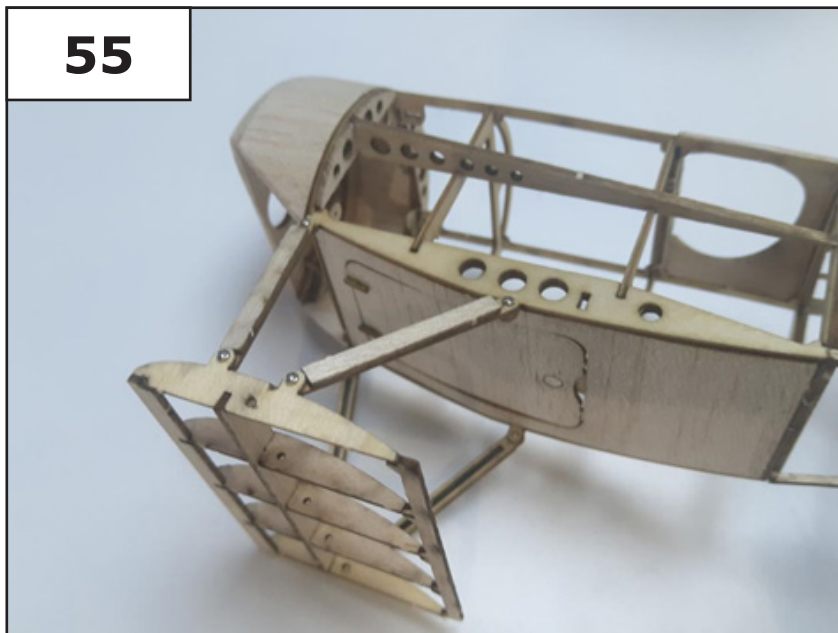

56

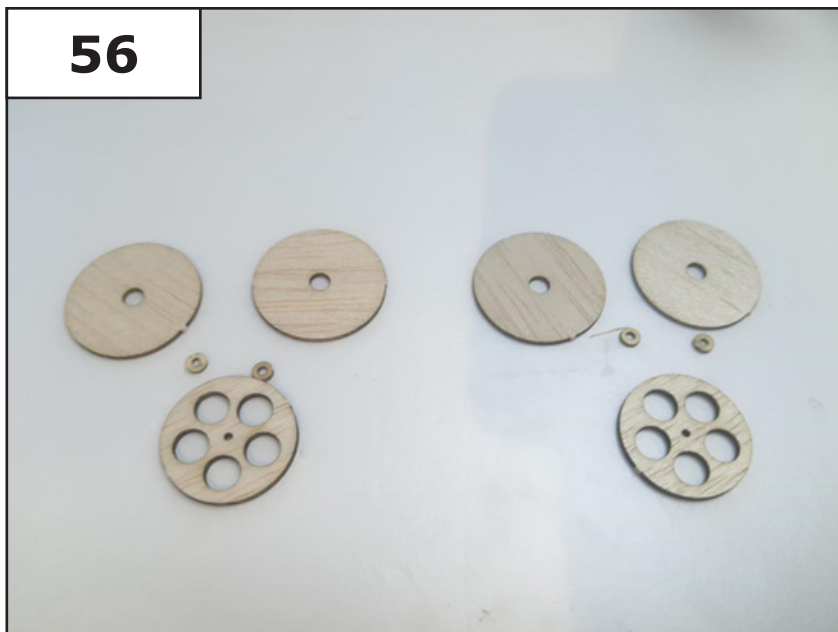

57

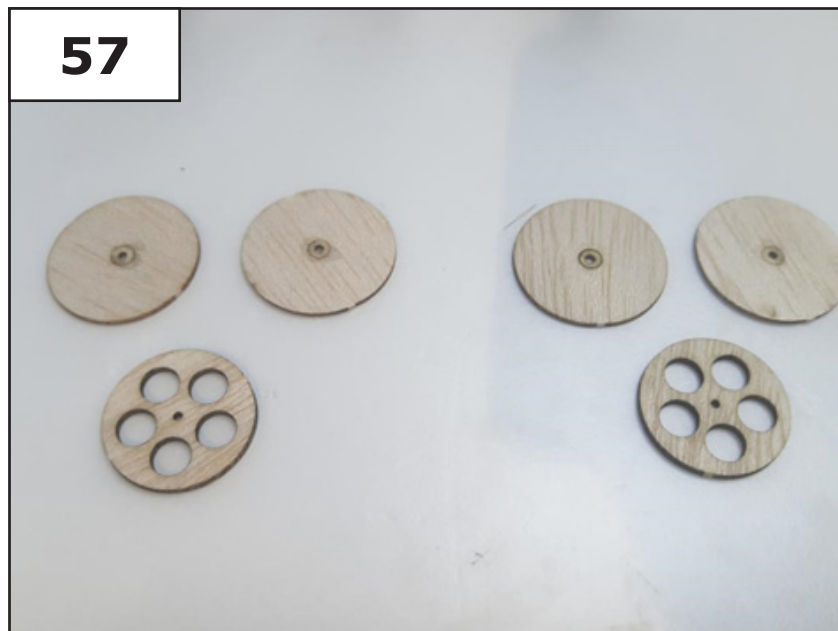

Teil 1 - Rahmen

58



59

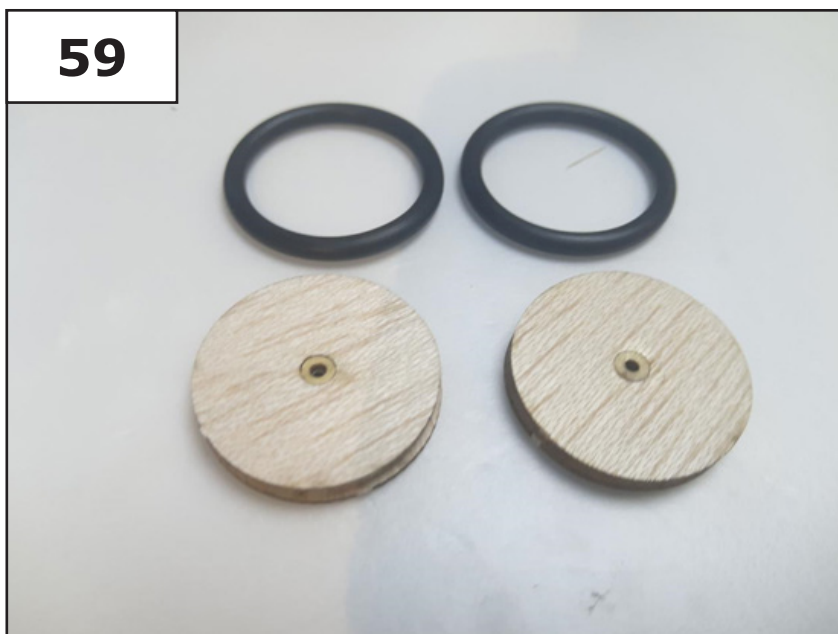

60



Teil 1 - Rahmen

61

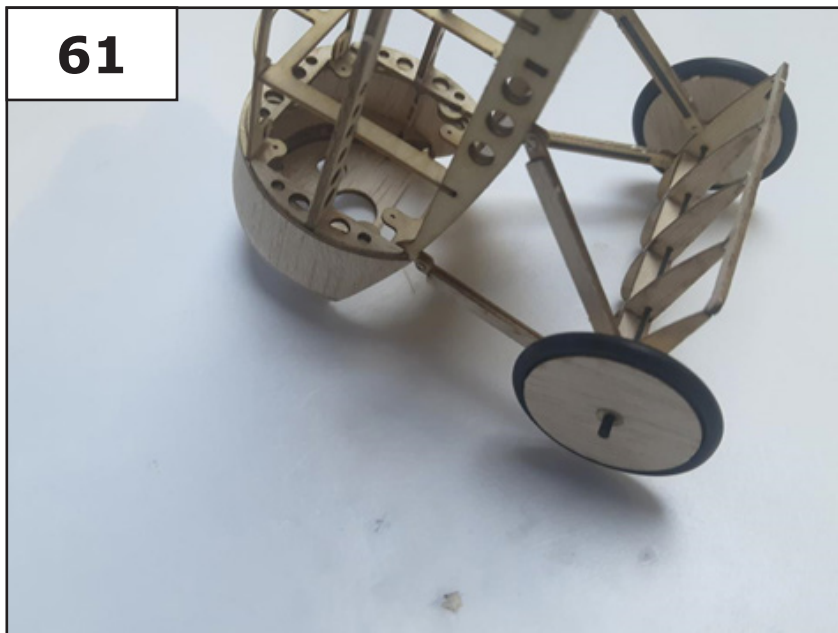

62

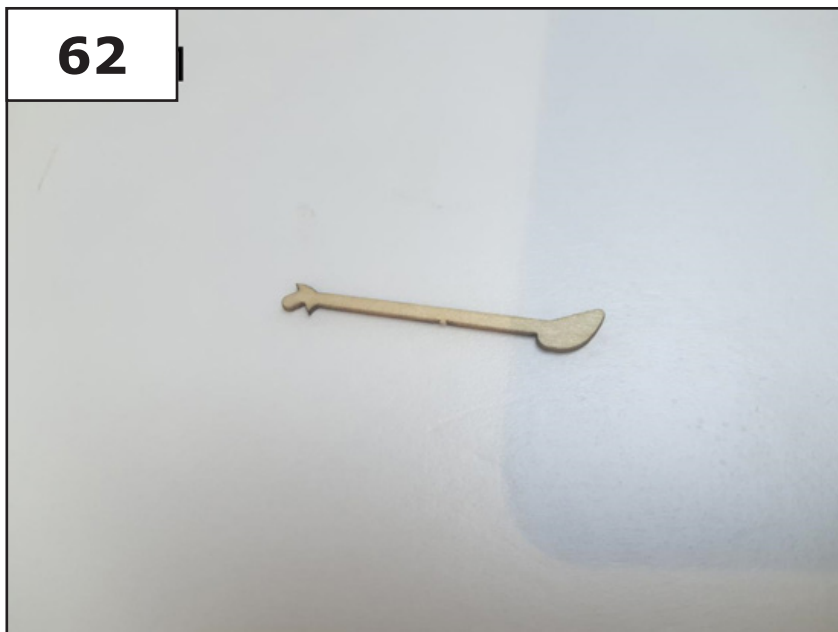

63



Teil 1 - Rahmen

64

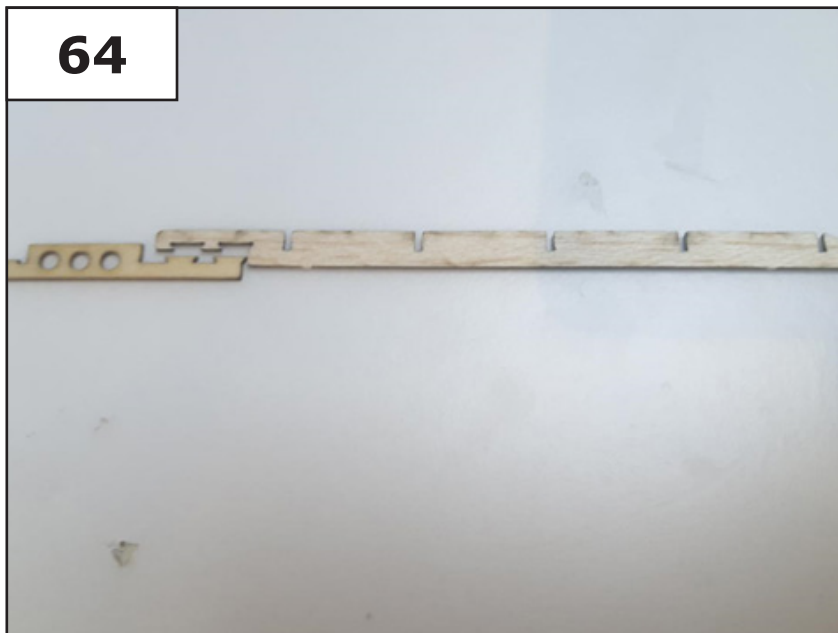

65

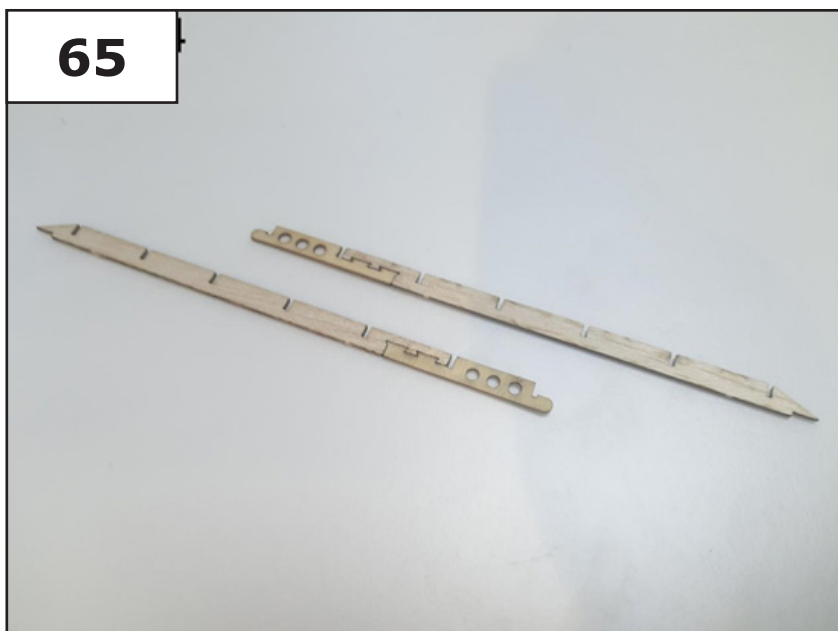

66

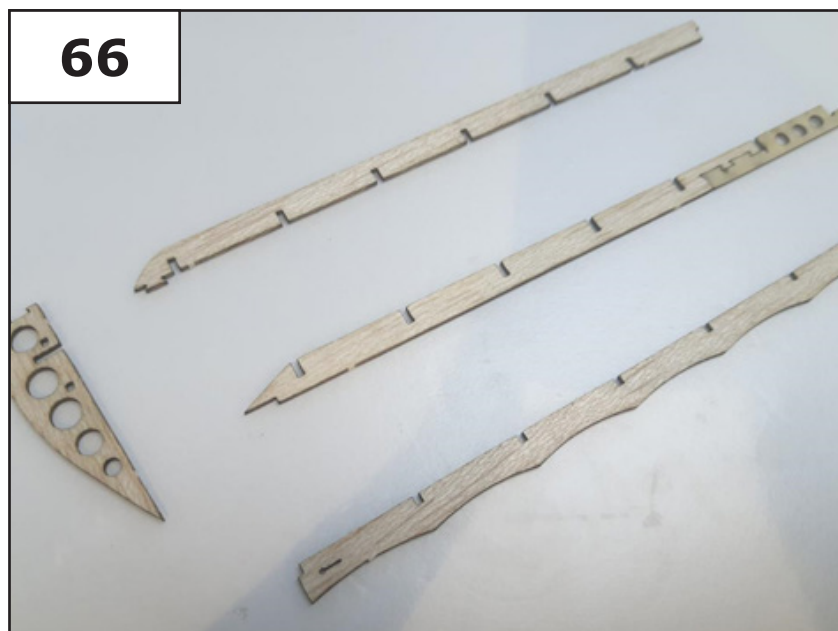

Teil 1 - Rahmen

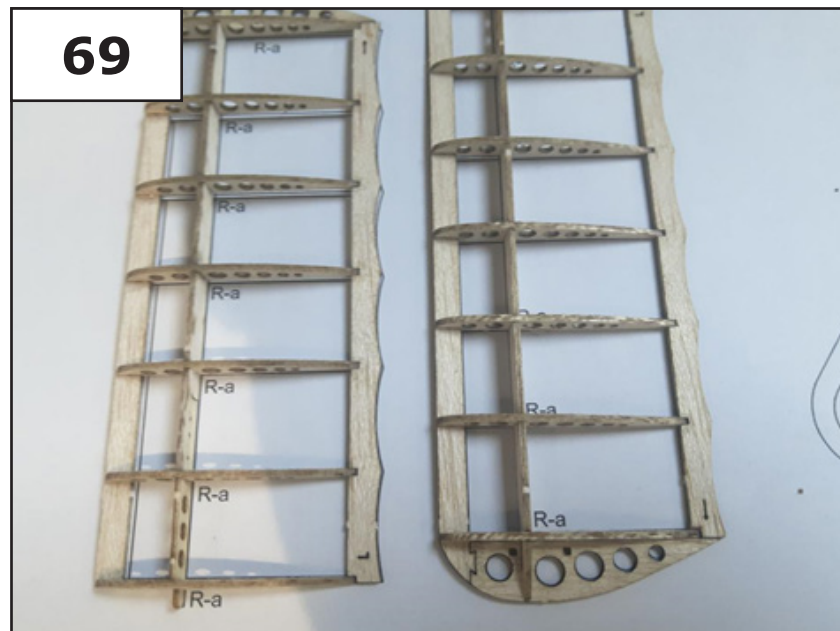
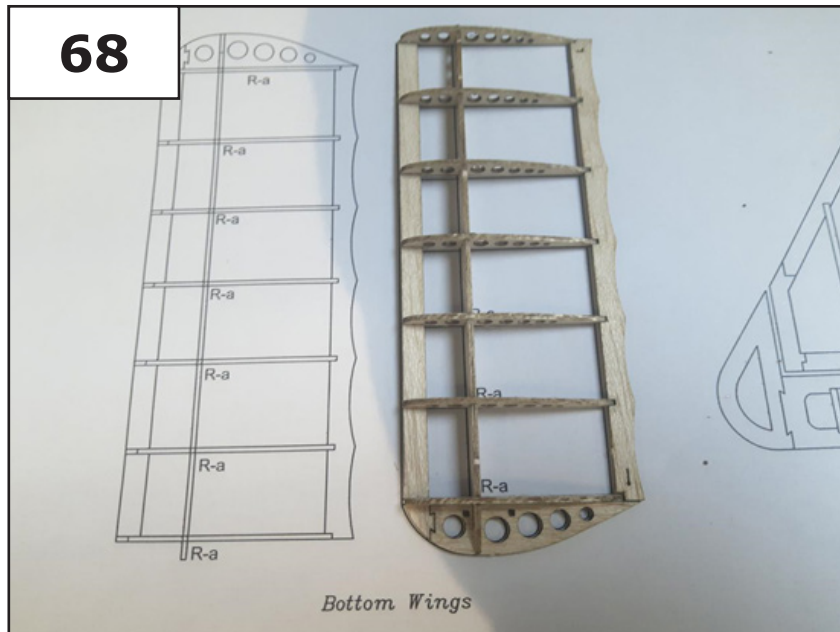
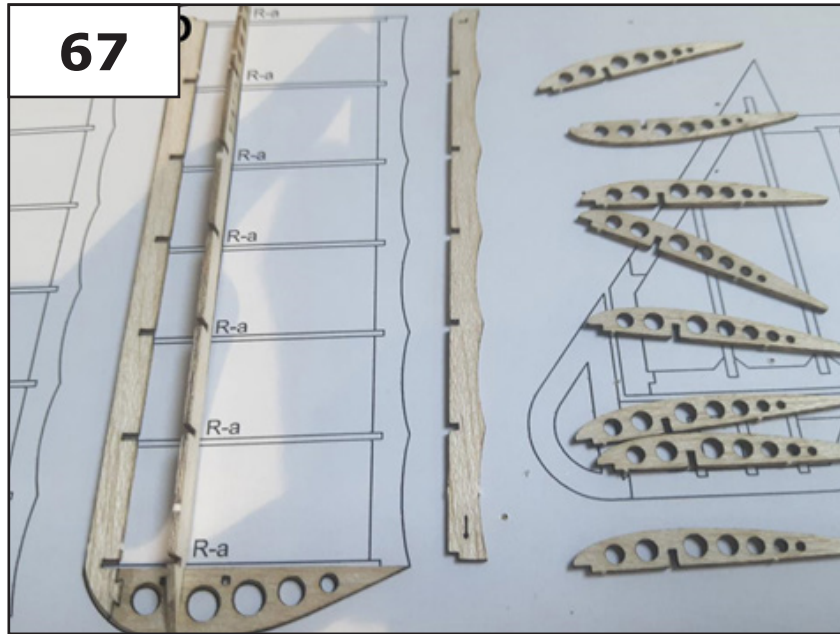

Teil 1 - Rahmen

70

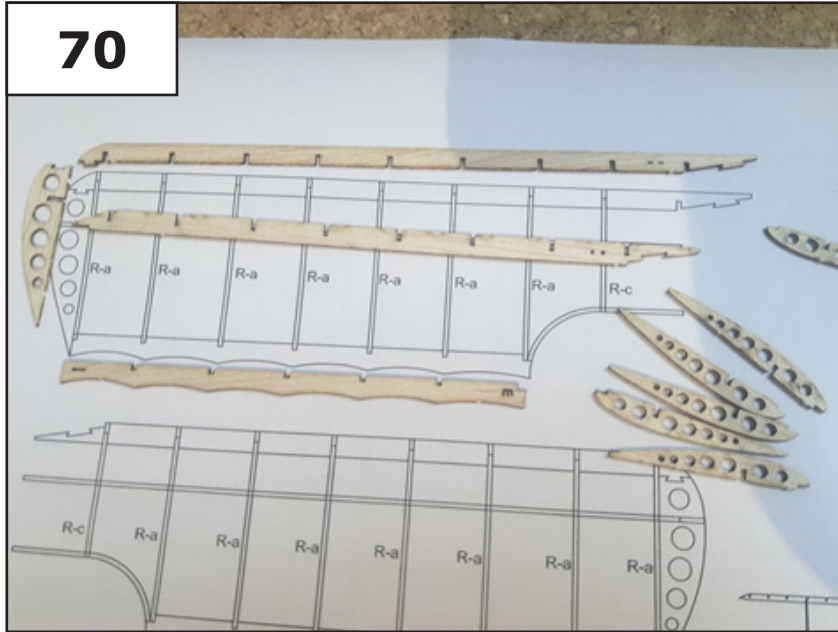

71

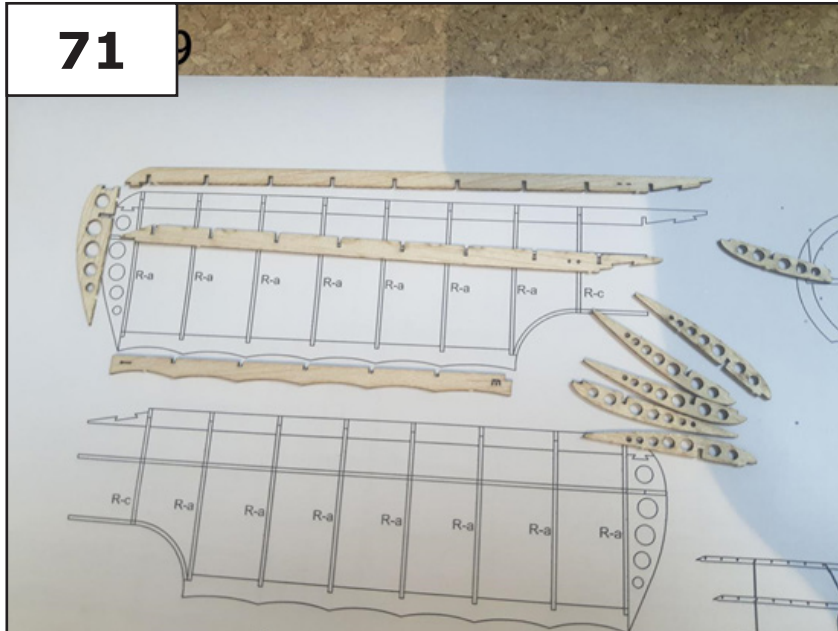

72

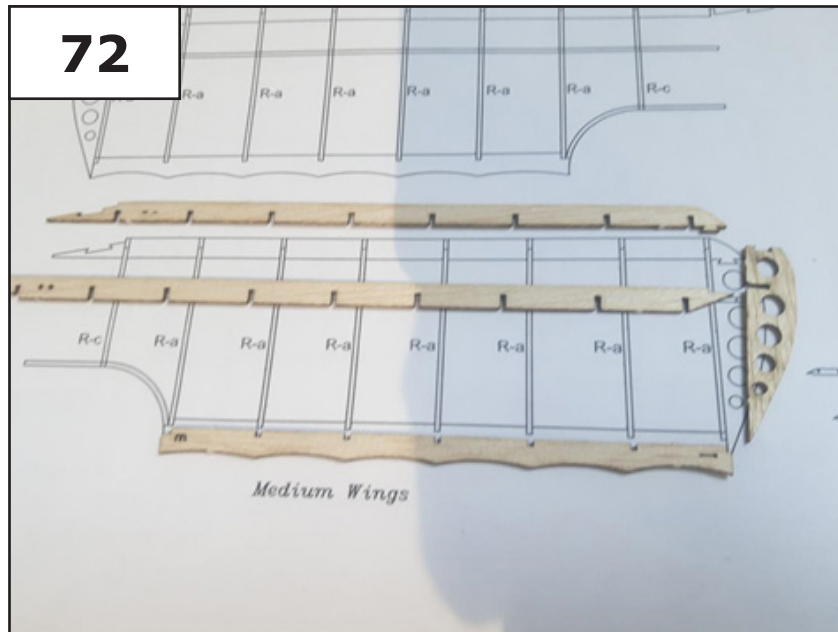

Teil 1 - Rahmen

73

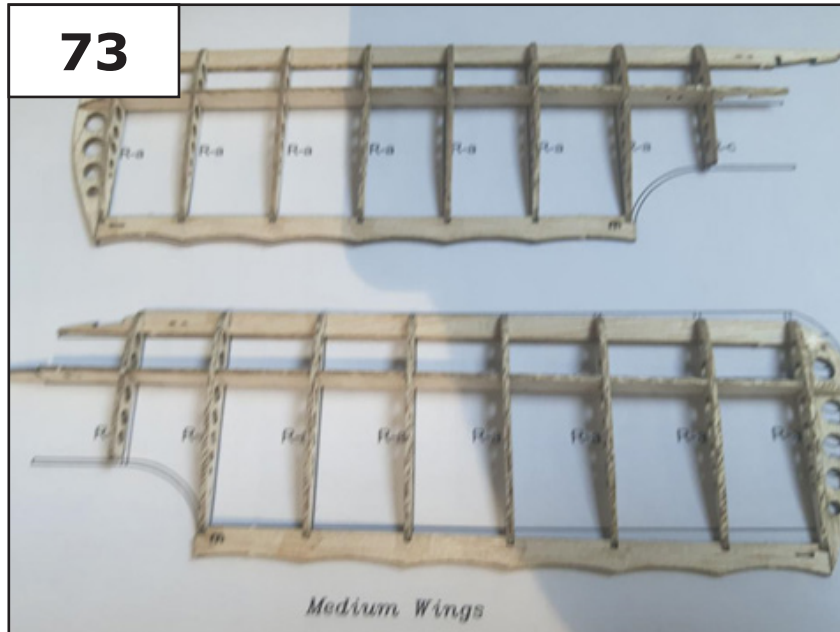

74

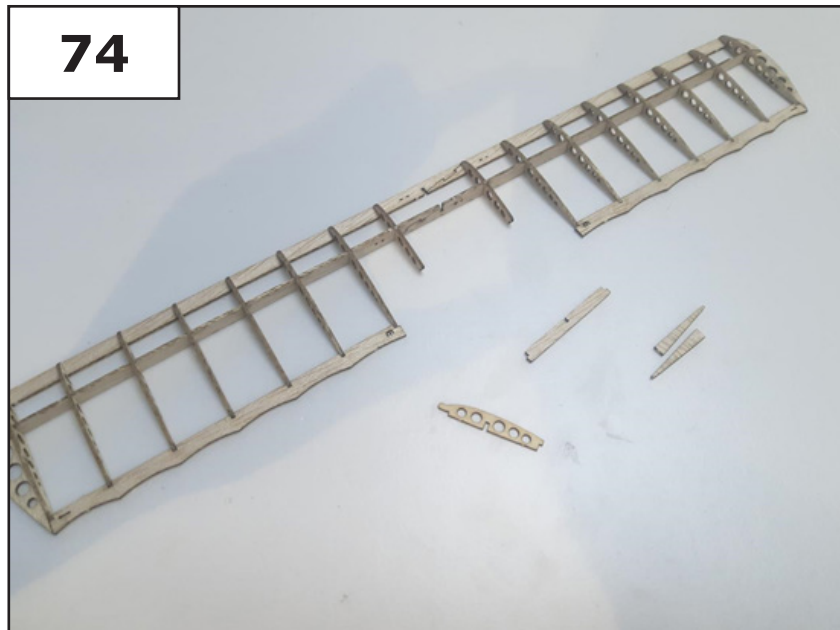

75

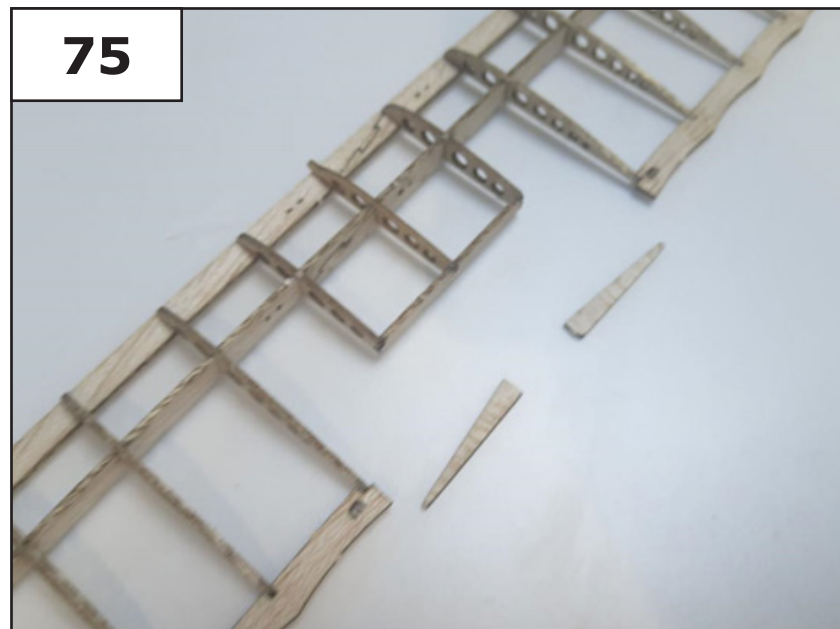

Teil 1 - Rahmen

76

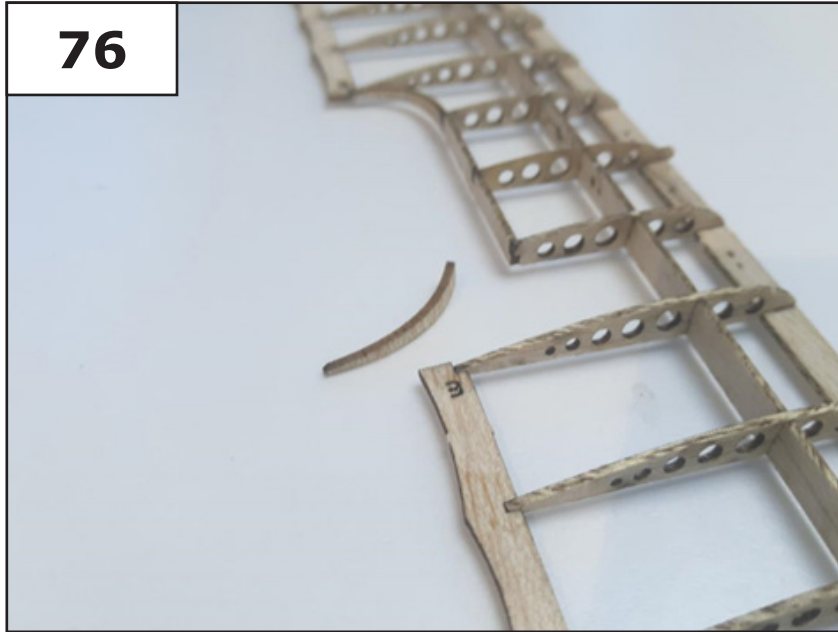

77

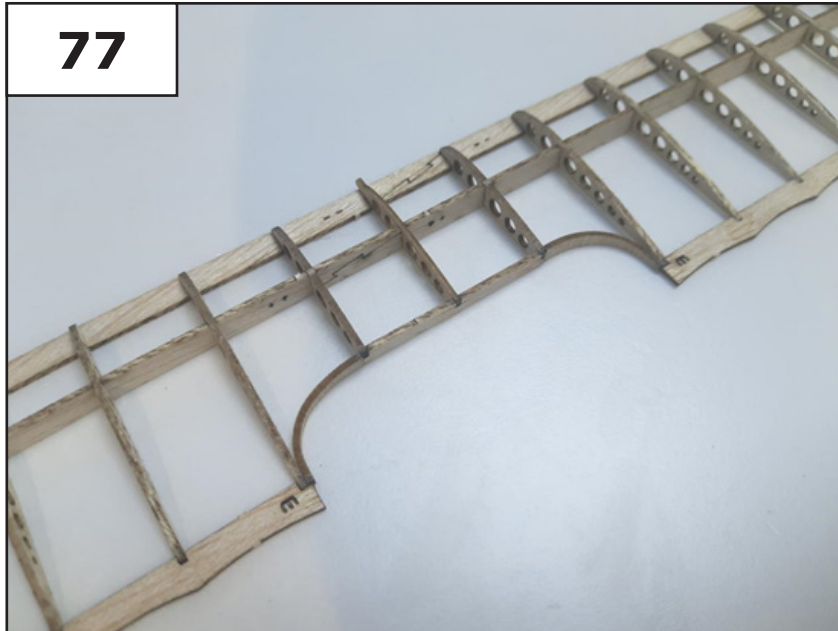

78

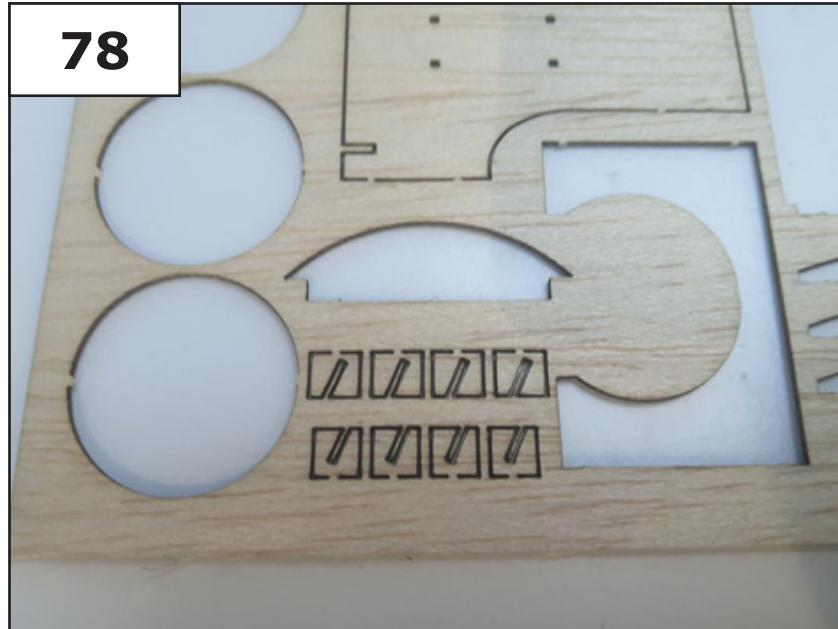

Teil 1 - Rahmen

79

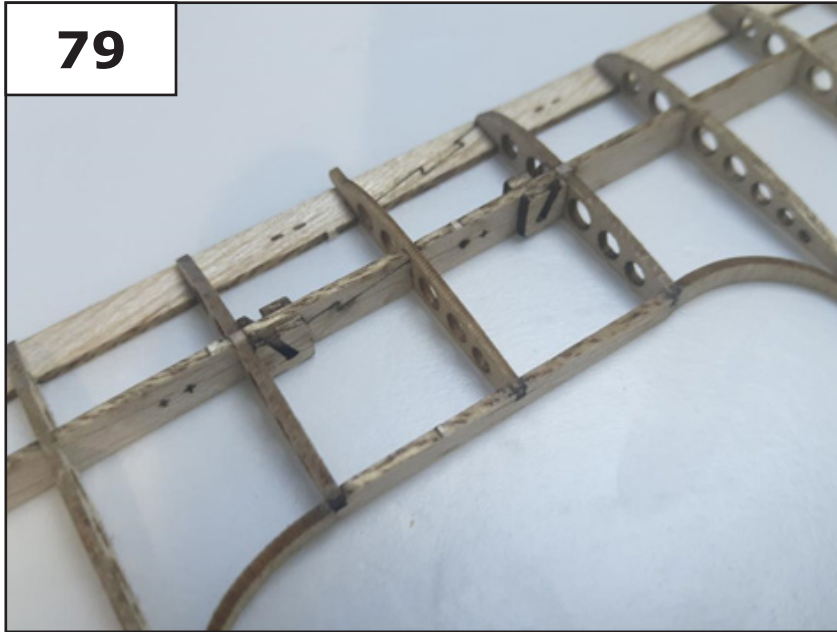

80

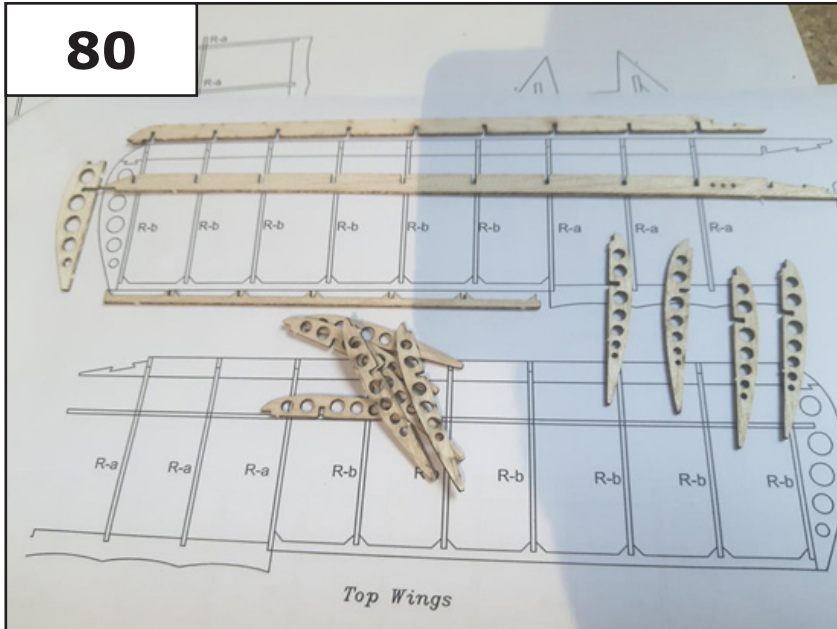

81

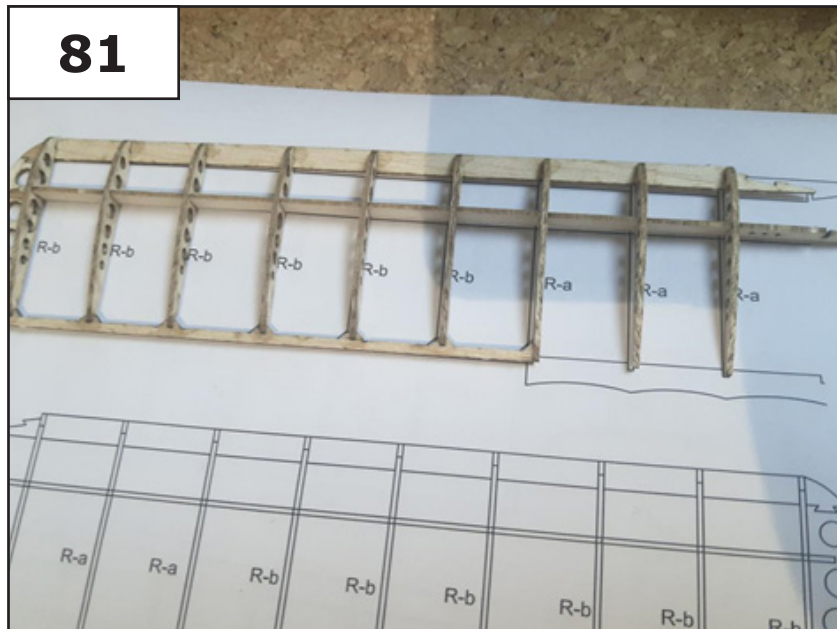

Teil 1 - Rahmen

82

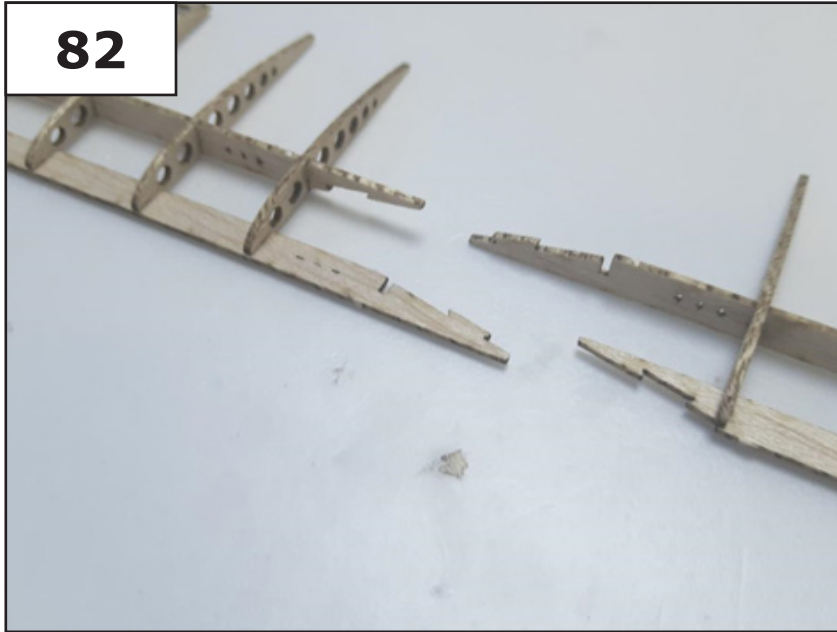

83

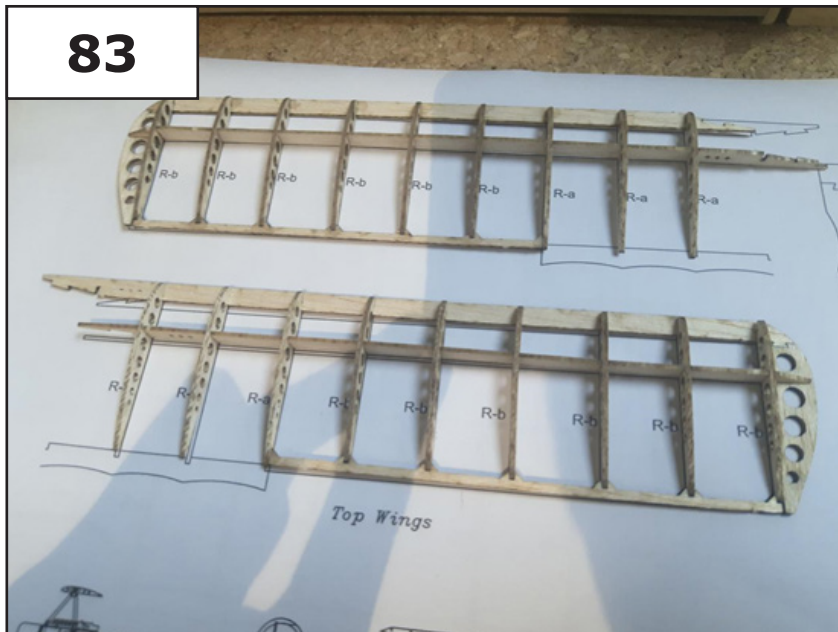

84

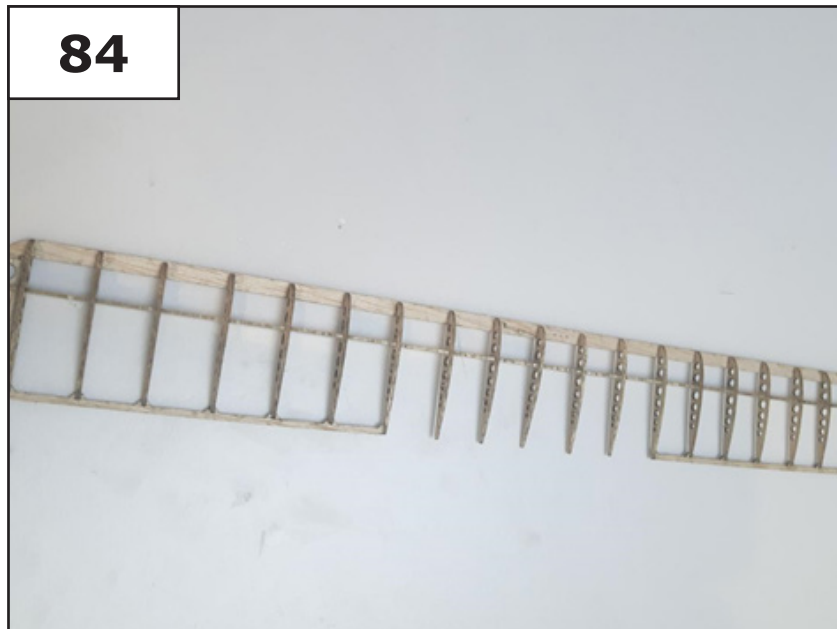

Teil 1 - Rahmen

85

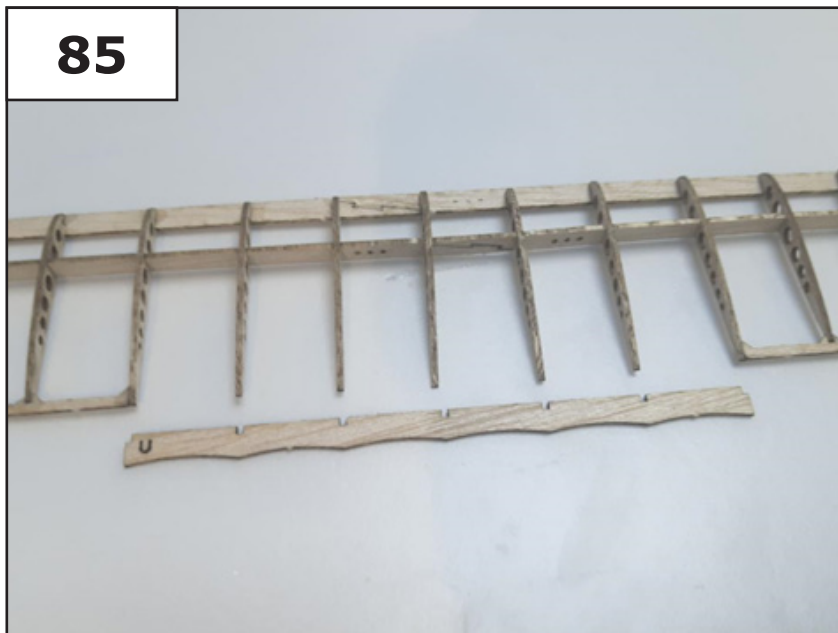

86

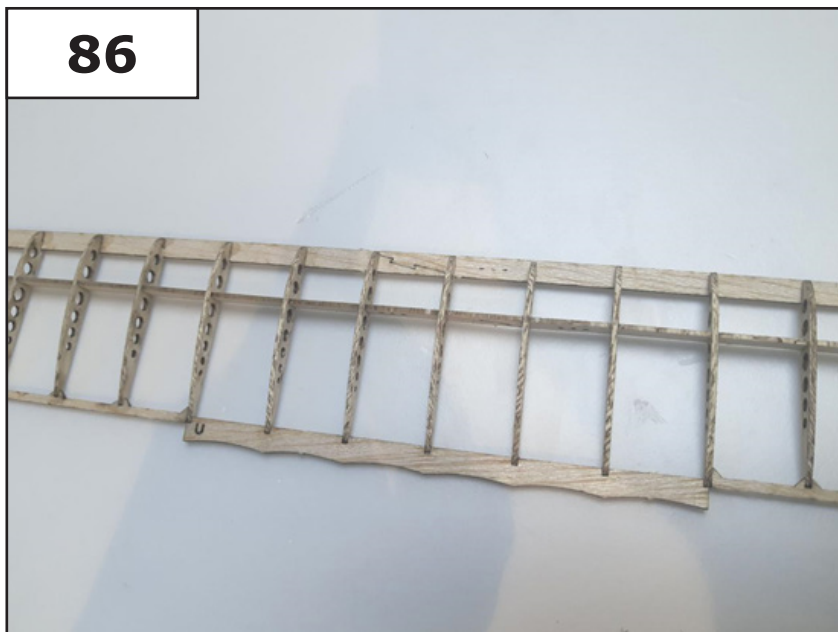

87

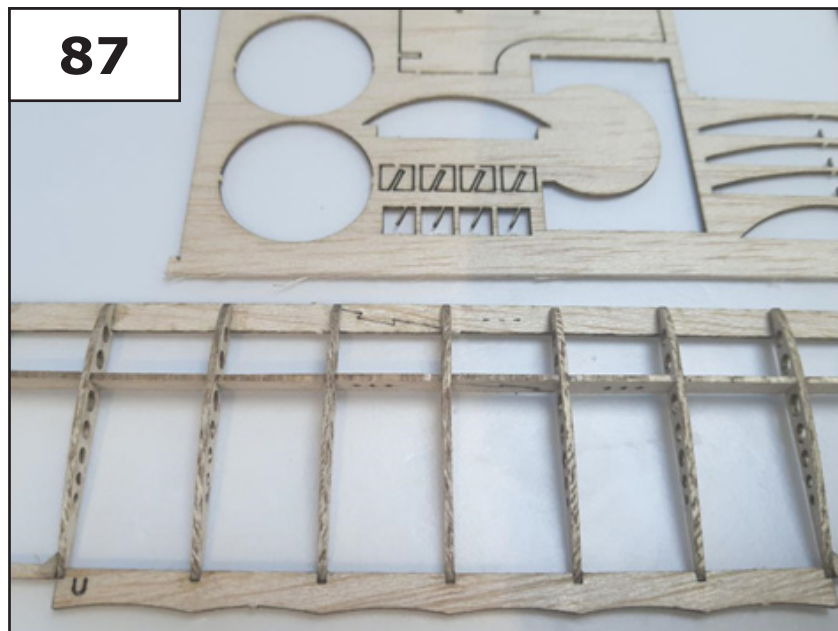

Teil 1 - Rahmen

88

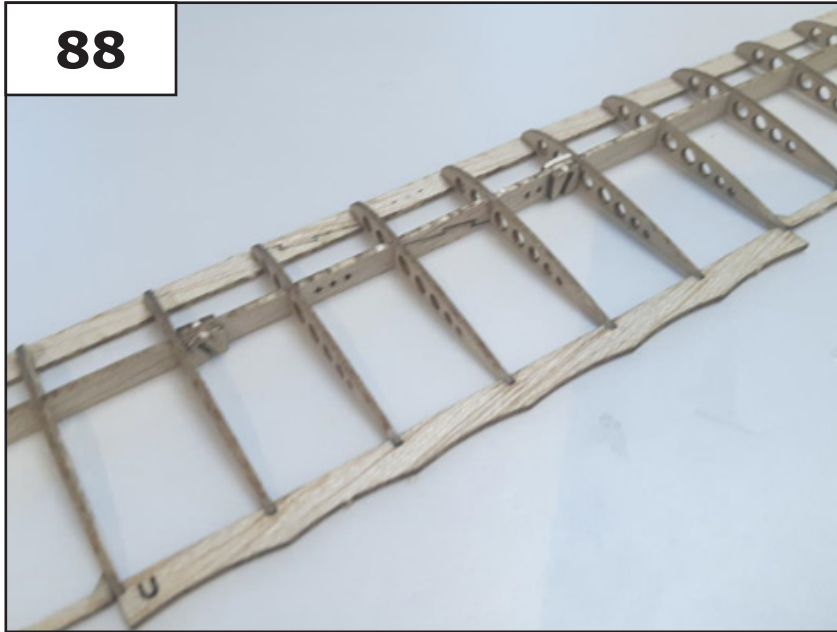

89

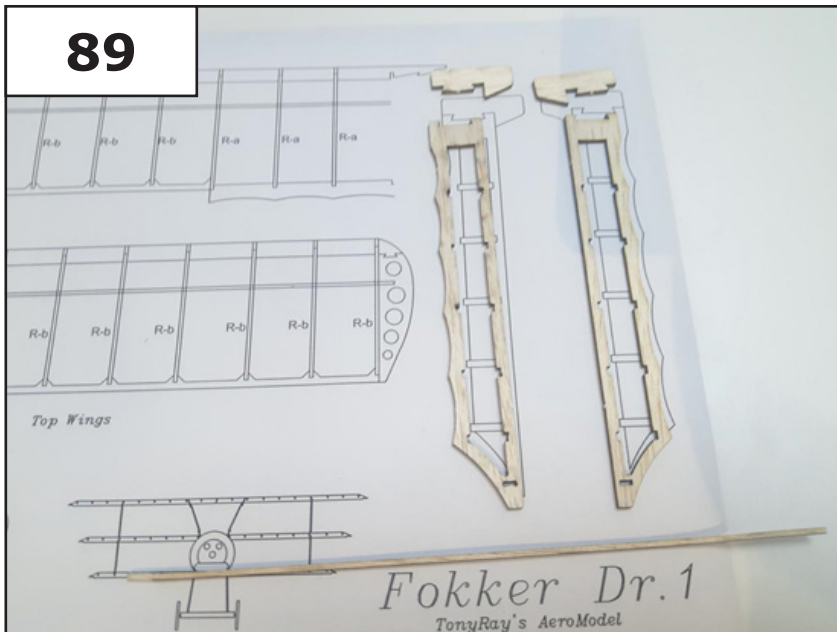

90

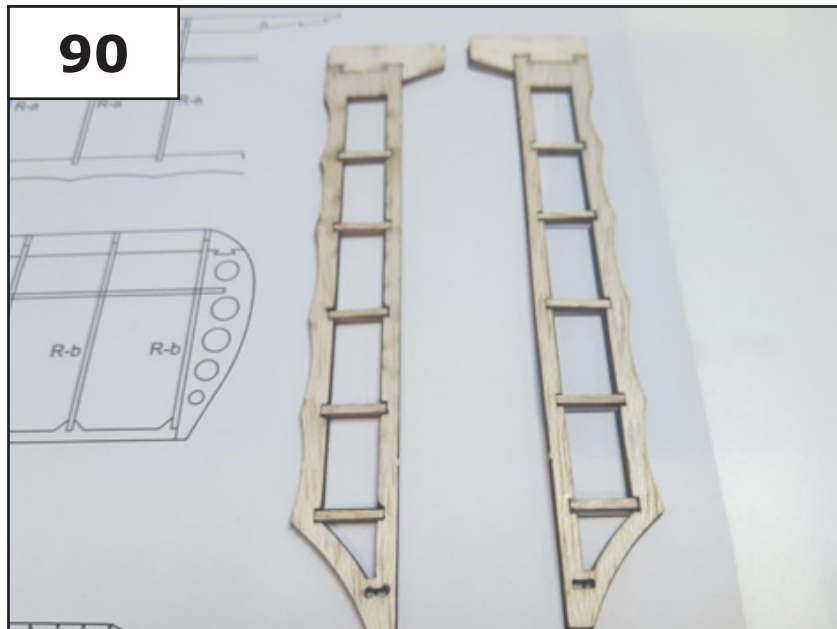

Teil 1 - Rahmen

91

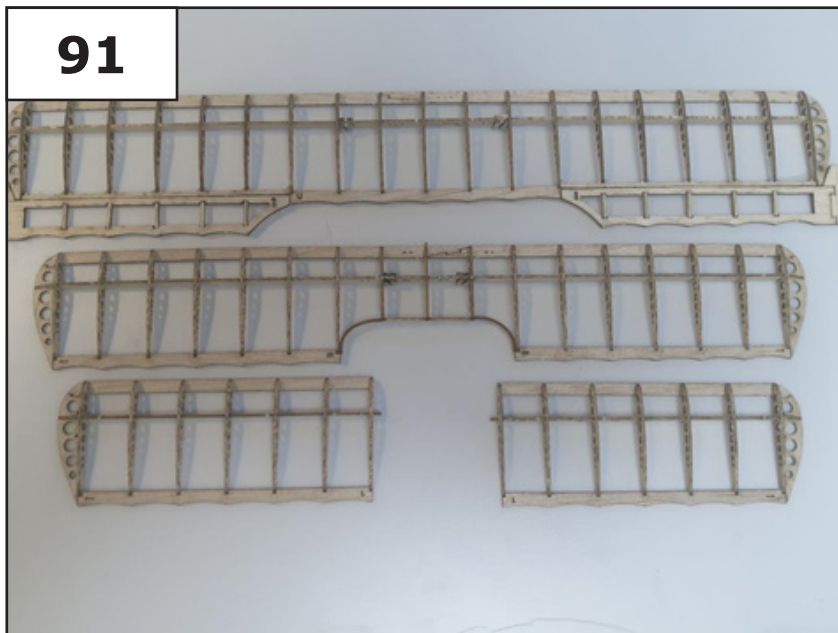

92

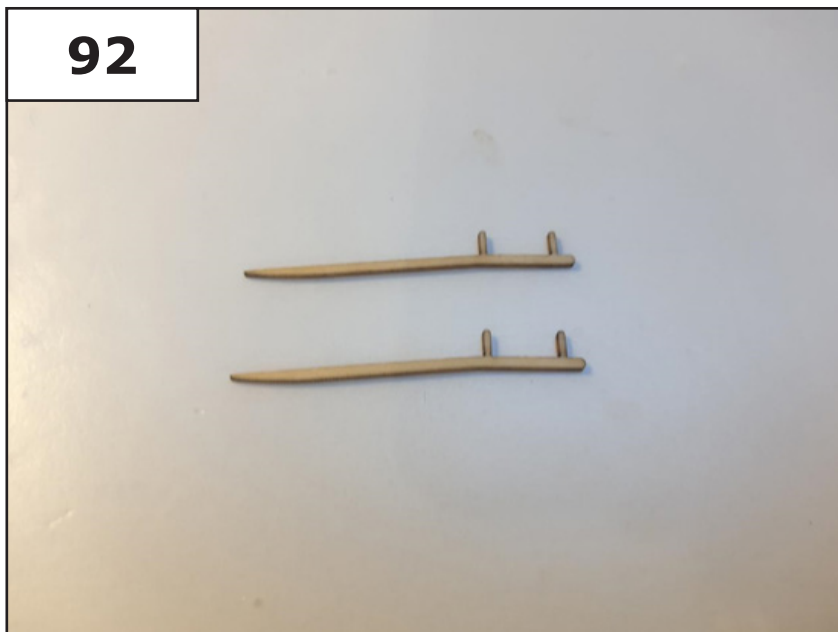

93

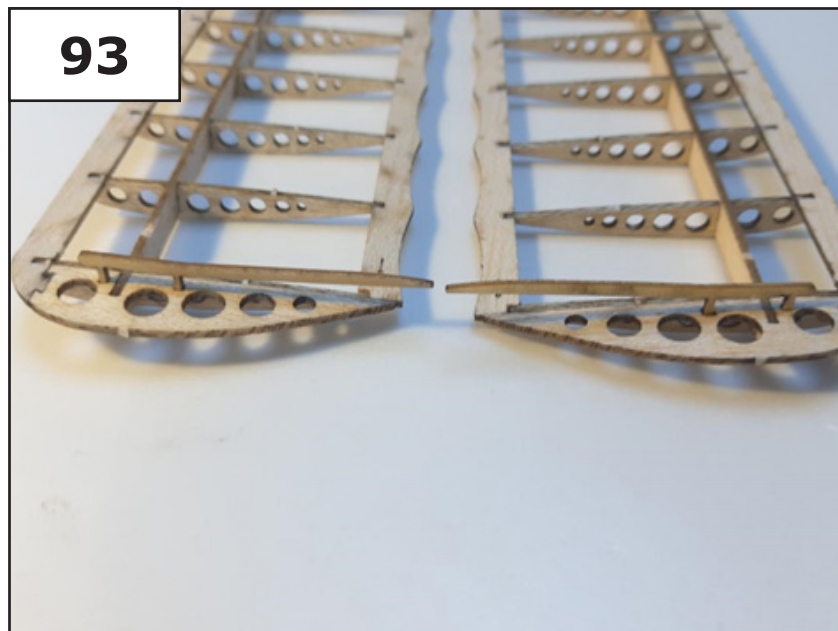

Teil 1 - Rahmen

94

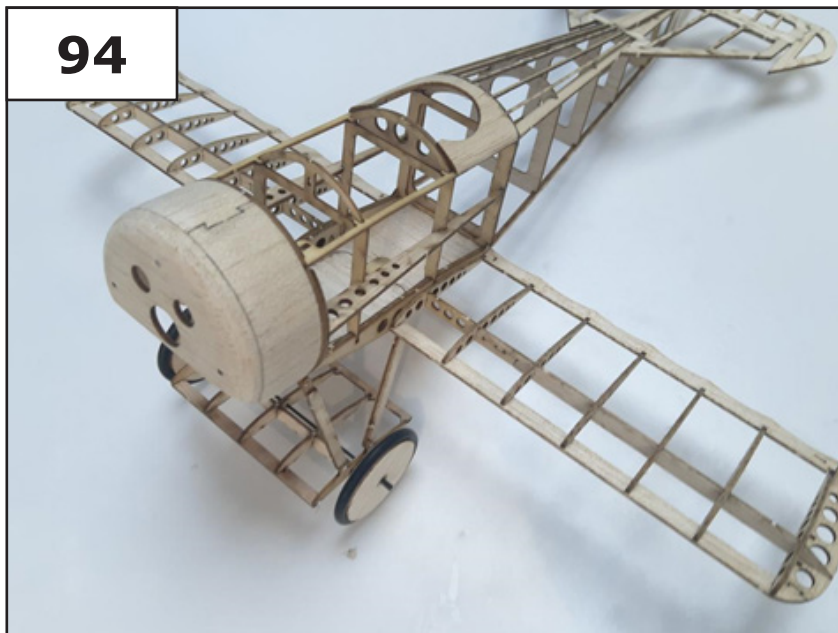

95

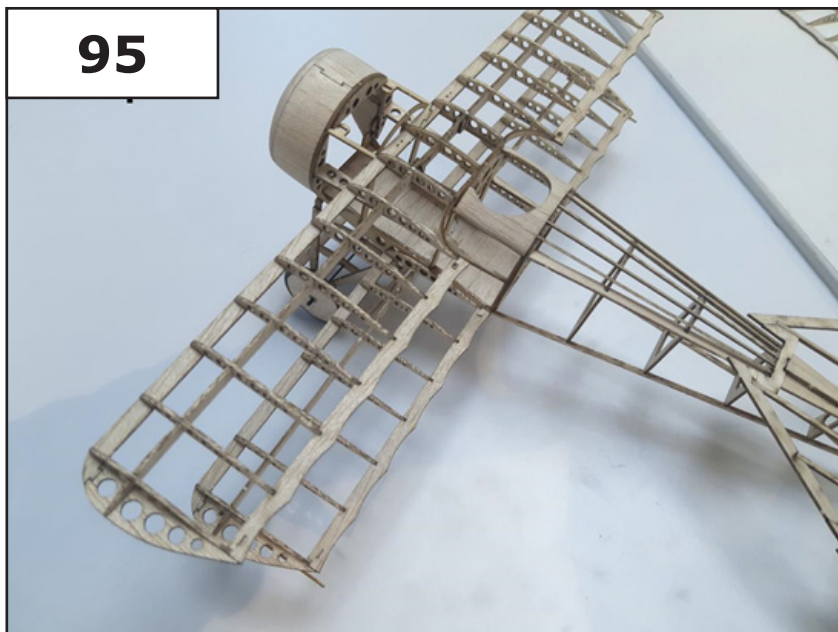

96



Teil 1 - Rahmen

97

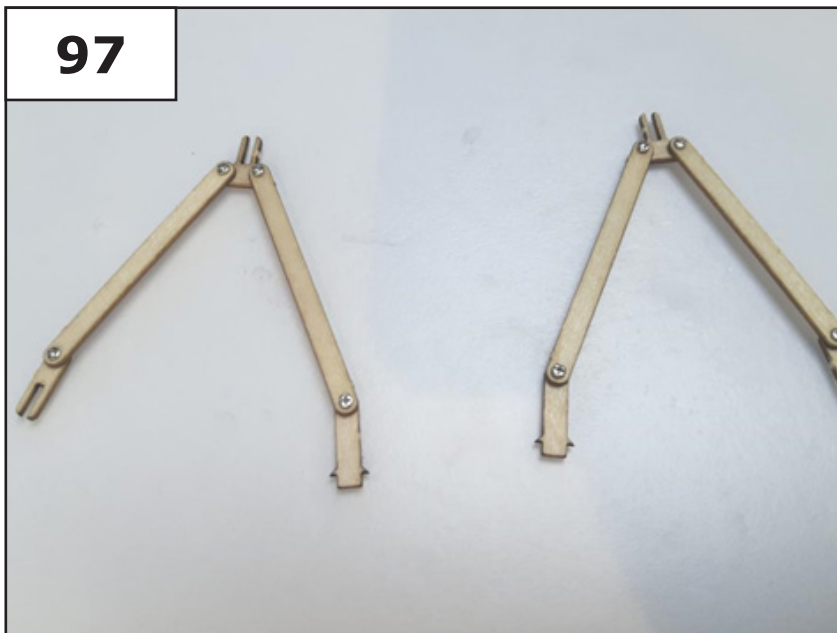

98

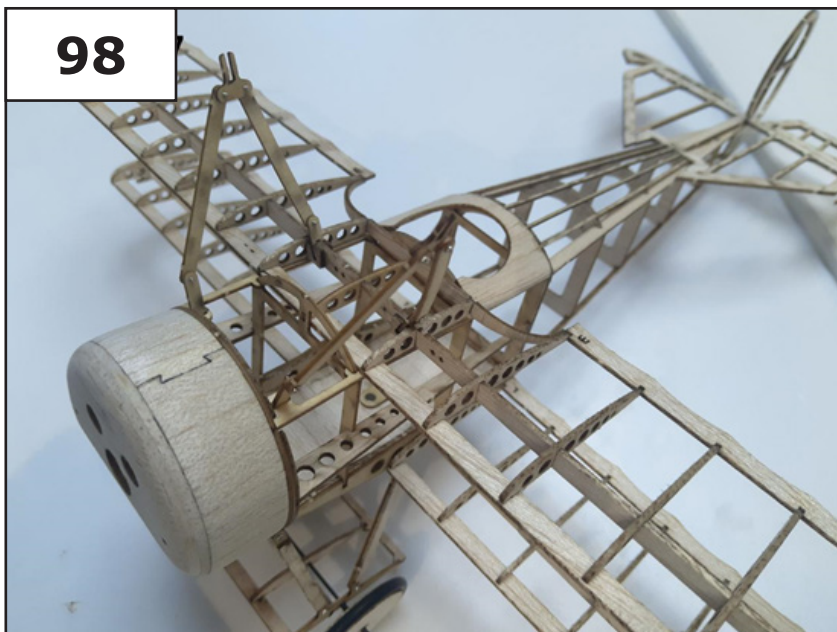

99



Teil 1 - Rahmen

100

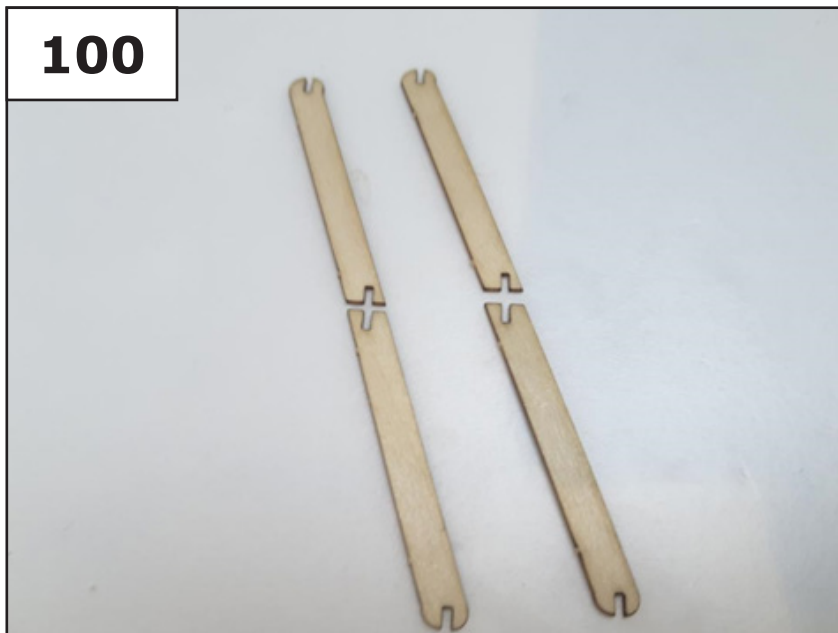

101

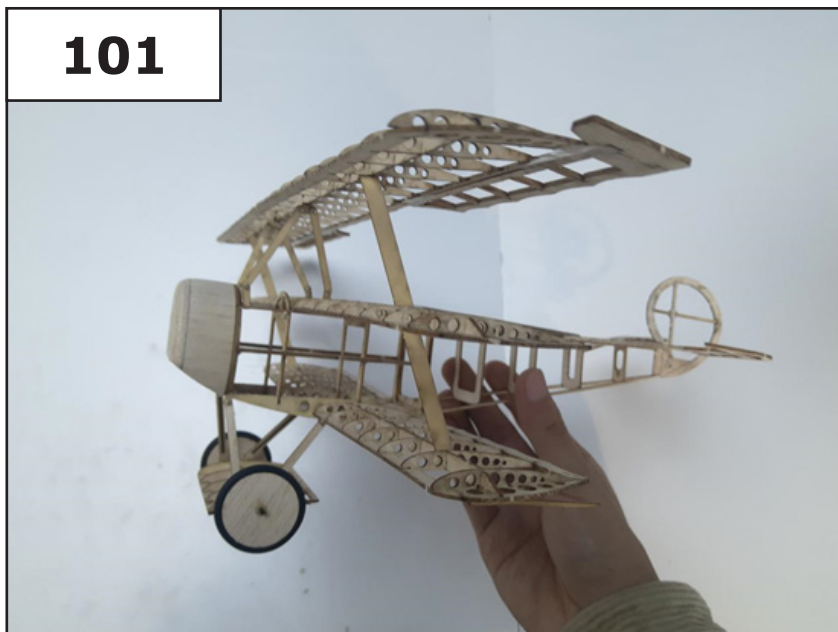

102

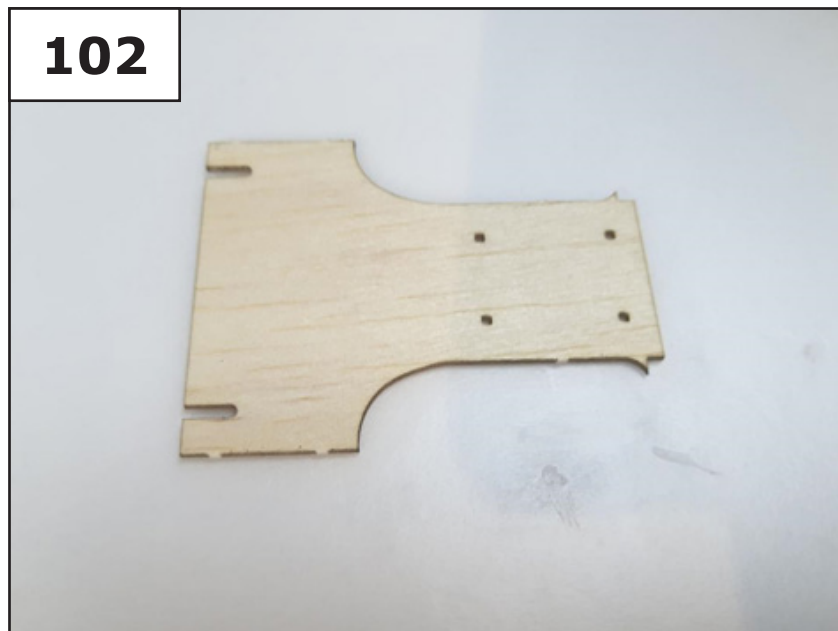

Teil 1 - Rahmen

103

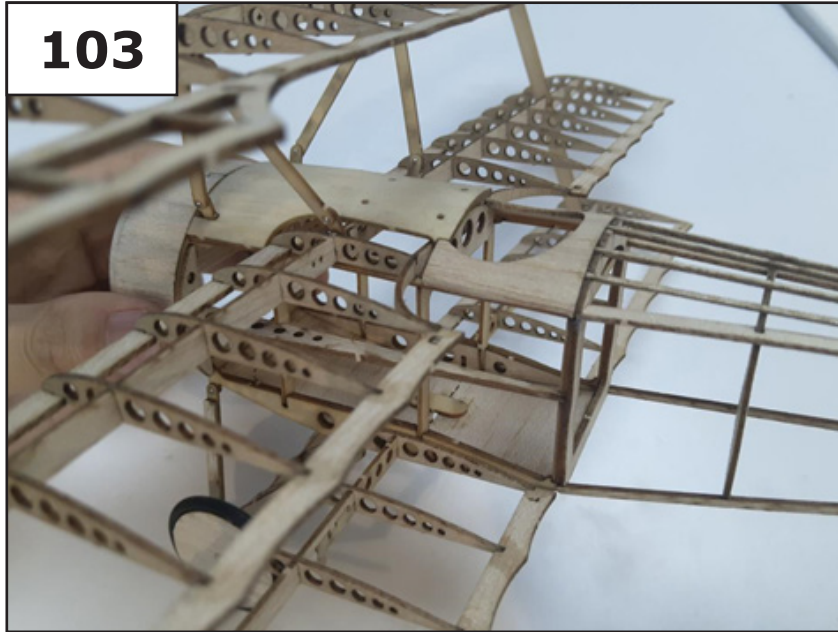

Teil 2 - Zubehör

1

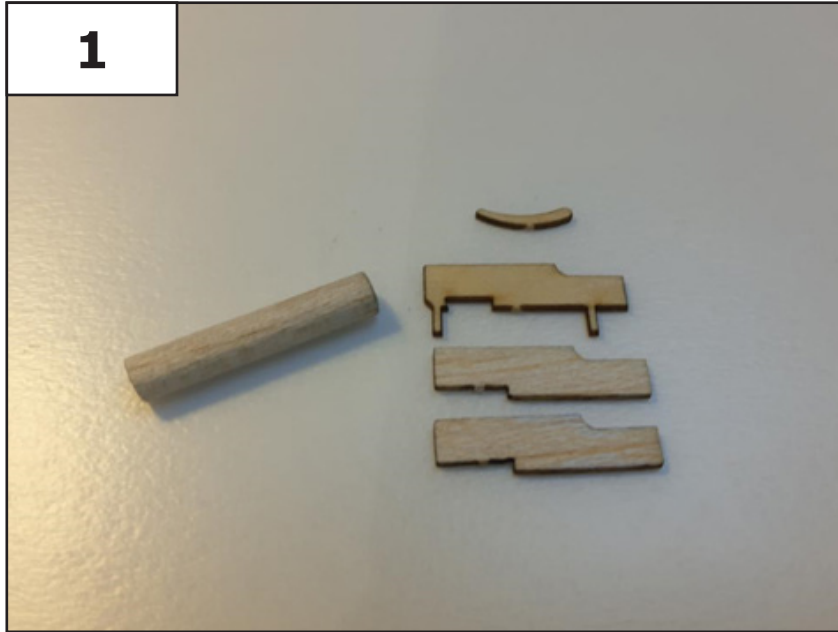

2

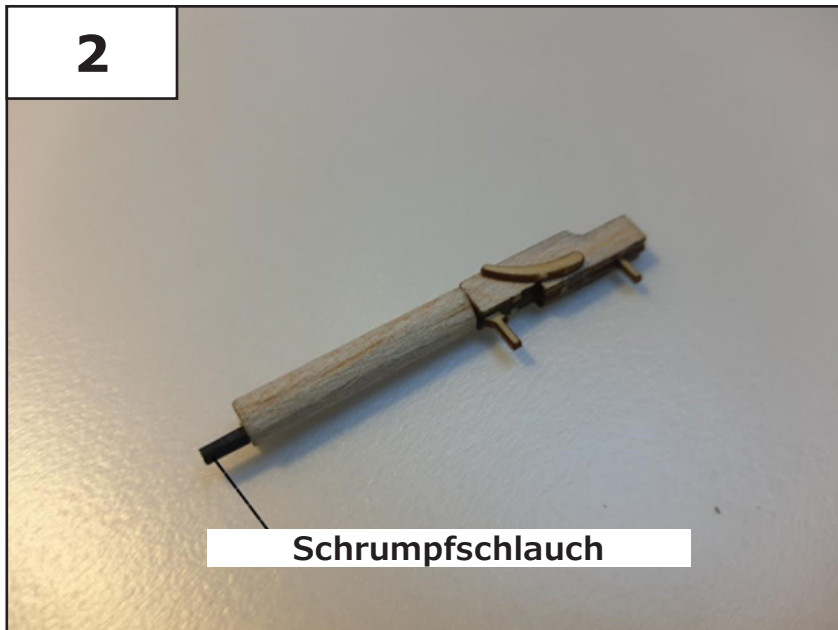

Schrumpfschlauch

3

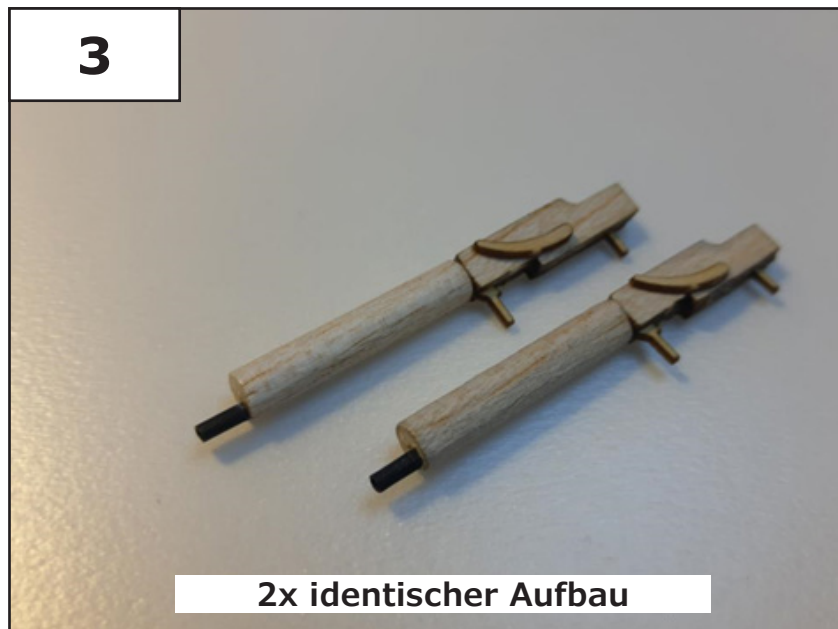

2x identischer Aufbau

Teil 2 - Zubehör

4



5



6

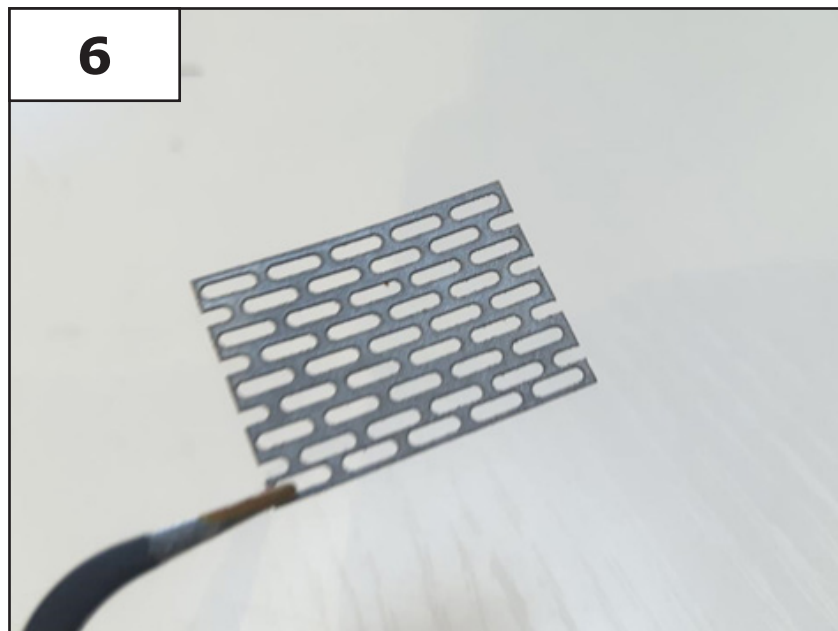

Teil 2 - Zubehör

7

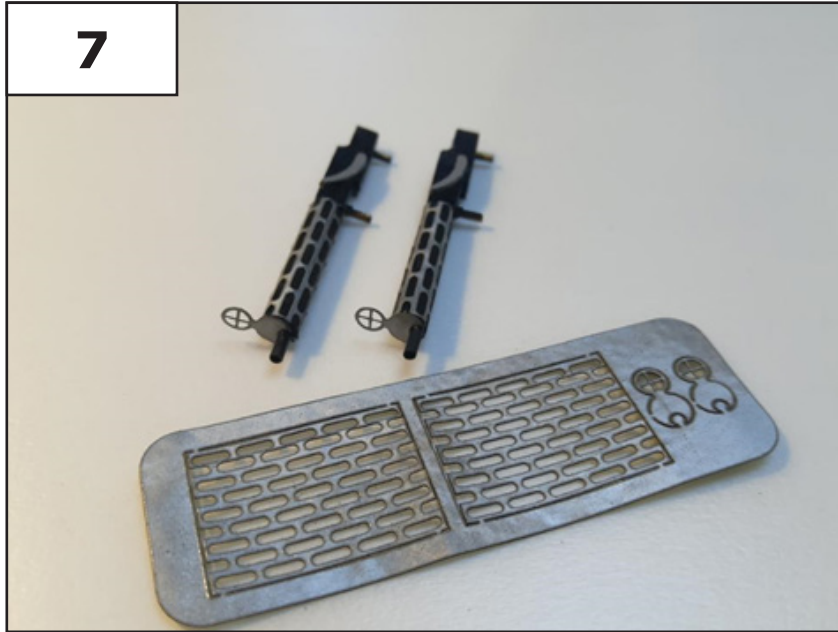

Teil 3 - Elektronik

1



2

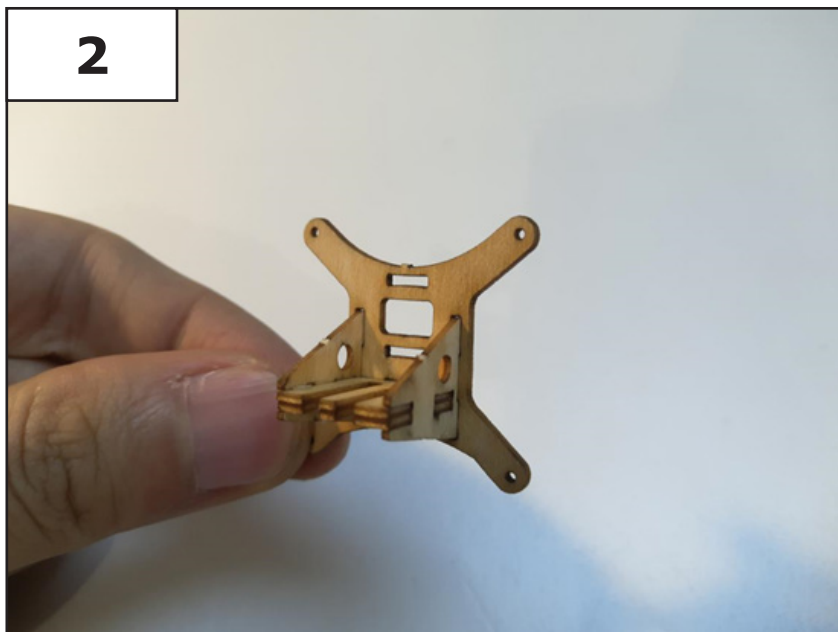

3

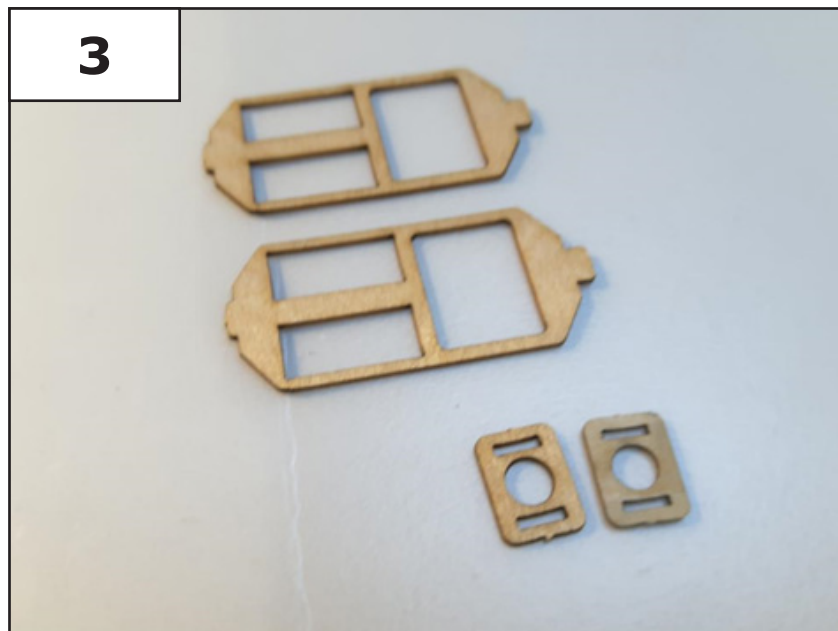

Teil 3 - Elektronik

4

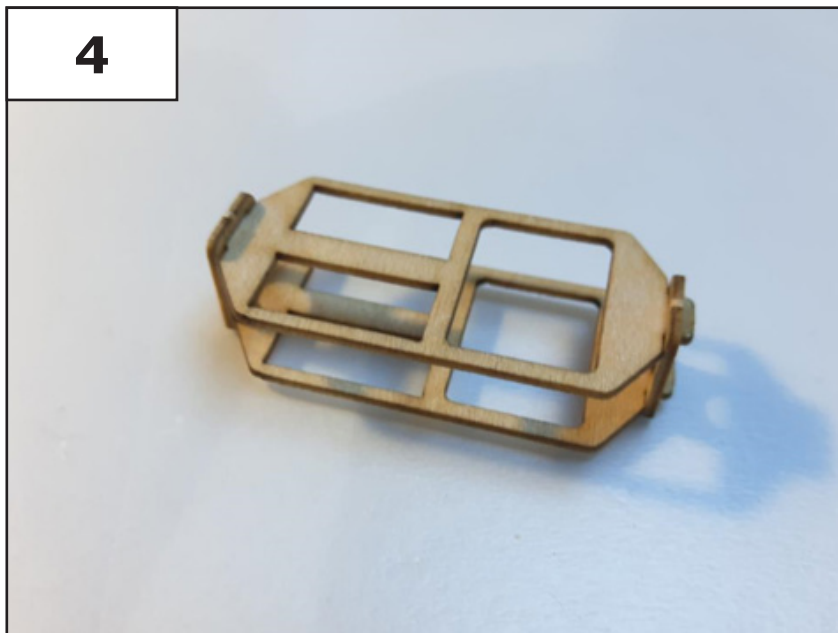

5

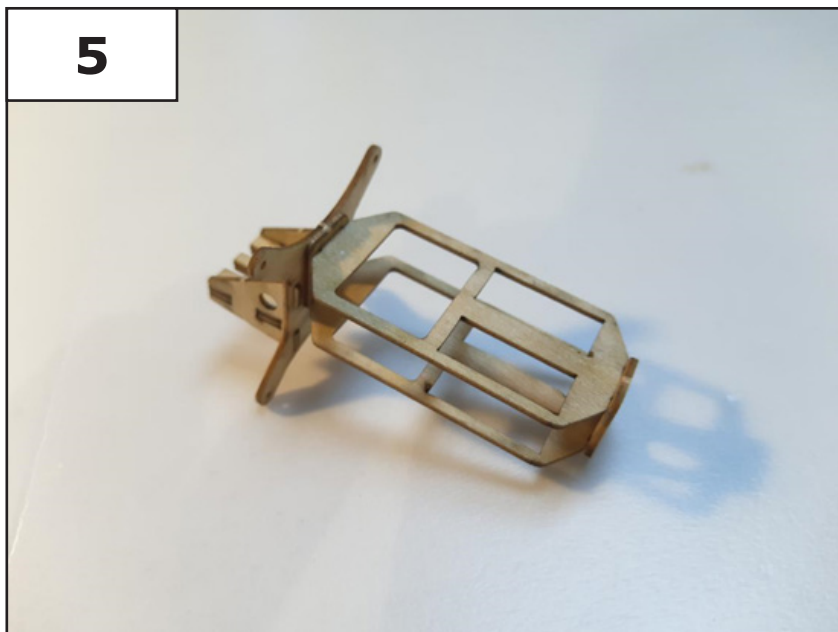

6

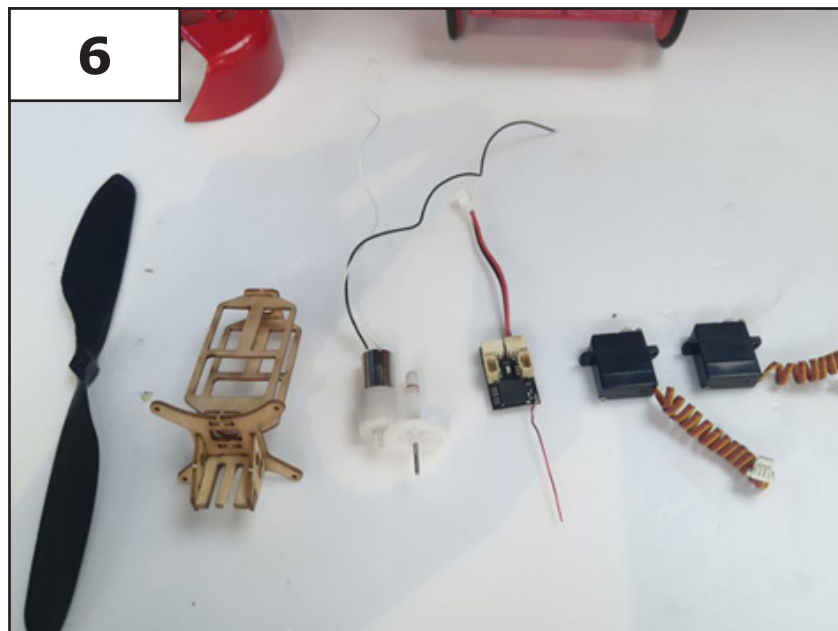

Teil 3 - Elektronik

7

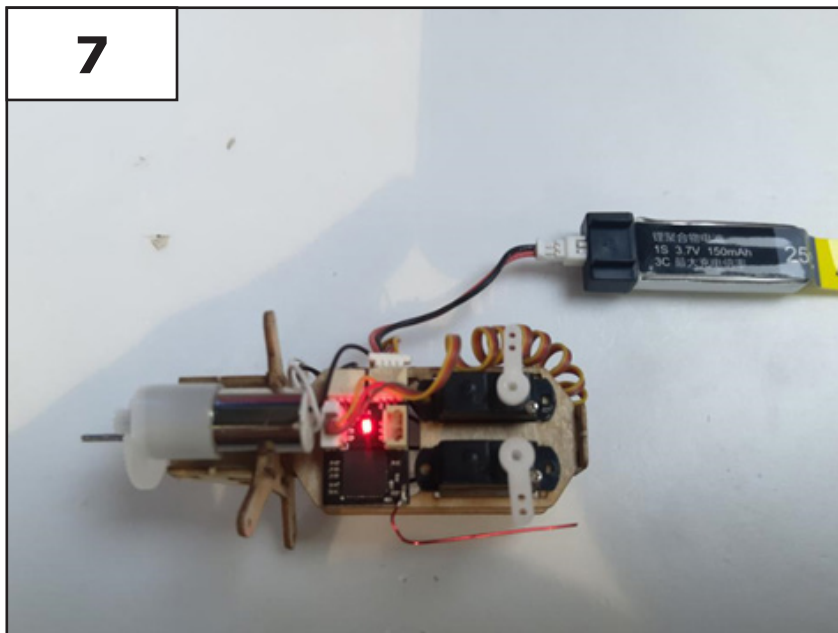

8

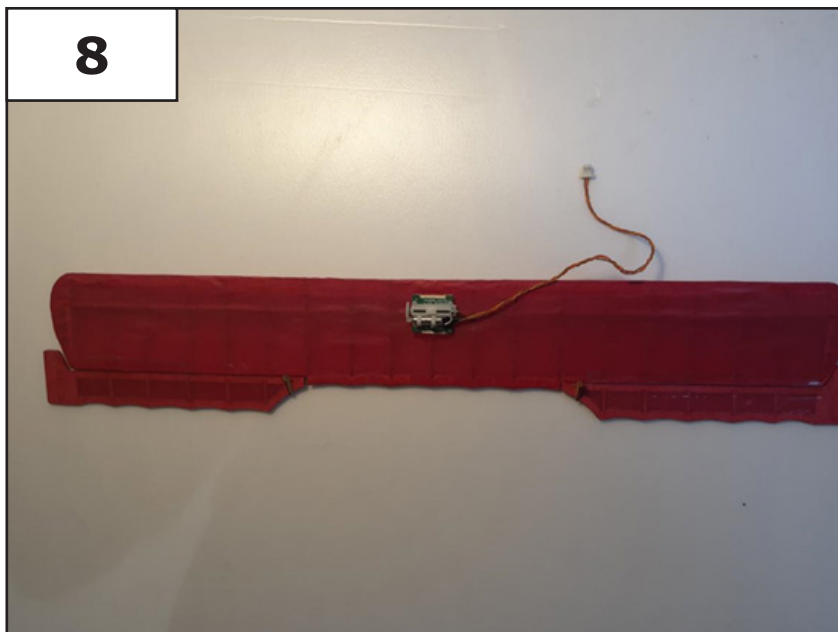

9

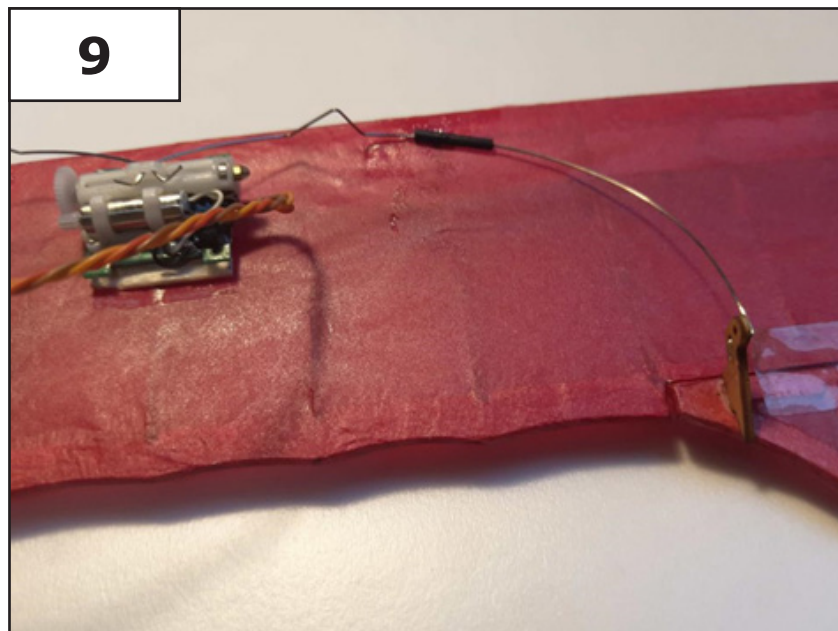

Teil 3 - Elektronik

10



11

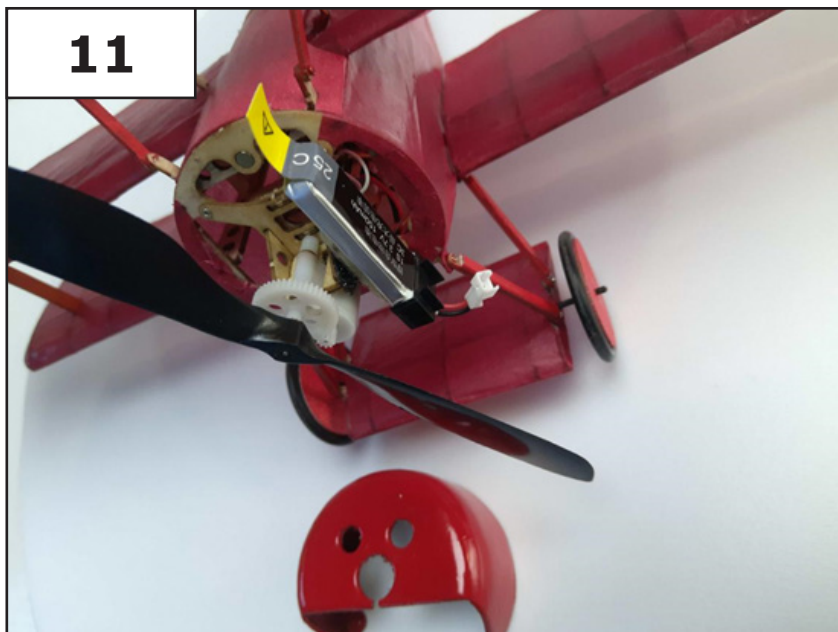

12



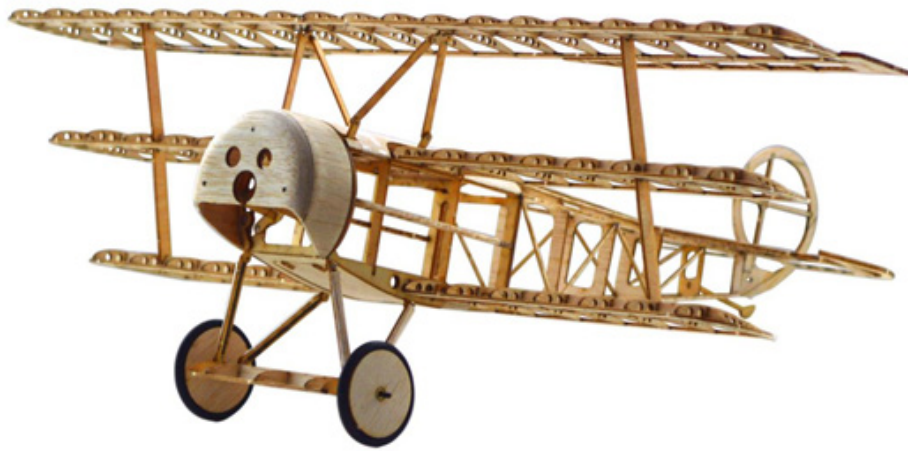

Den Rohbau des Modells haben Sie nun fertiggestellt.
Für die Bespannung empfehlen wir JAPAN Air Bespannpapier aus unserem Shop.

www.pichler.de

Auf der Artikelseite finden Sie ebenfalls eine Anleitung wie Sie das Modell optimal bespannen können.



PICHLER

Pichler MODELLBAU GmbH
Lauterbachstr. 19 | 84307 | Eggenfelden
08721/508266-0 | mail@pichler.de